

Click to view price, real time Inventory,
Delivery & Lifecycle Information ;

LTM4604EV#PBF

Analog Devices Inc.

Switching Voltage Regulators L V, 4A DC/DC Module Reg w/
Track

Any questions, please feel free to contact us.
info@kaimte.com

Low Voltage, 4A DC/DC μ Module Regulator with Tracking

FEATURES

- Complete Standalone Power Supply
- Wide Input Voltage Range: 2.375V to 5.5V
- 4A DC, 5A Peak Output Current
- 0.8V to 5V Output
- Output Voltage Tracking
- $\pm 2\%$ Maximum Total DC Output Error
- UltraFast™ Transient Response
- Current Mode Control
- Current Foldback Protection, Parallel/Current Sharing
- Small and Very Low Profile Package: 15mm \times 9mm \times 2.32mm LGA

APPLICATIONS

- Telecom and Networking Equipment
- Servers, ATCA Cards
- Industrial Equipment

Please refer to the LTM4604A for easier PC board layout and assembly due to increased spacing between land grid pads.

DESCRIPTION

The LTM[®]4604 is a complete 4A switch mode step-down μ Module[®] (micromodule) regulator. Included in the package are the switching controller, power FETs, inductor and all support components. Operating over an input voltage range of 2.375V to 5.5V, the LTM4604 supports an output voltage range of 0.8V to 5V, set by a single resistor. This high efficiency design delivers up to 4A continuous current (5A peak). Only bulk input and output capacitors are needed to complete the design.

The low profile package (2.32mm) enables utilization of unused space on the bottom of PC boards for high density point of load regulation. High switching frequency and a current mode architecture enable a very fast transient response to line and load changes without sacrificing stability. The device supports output voltage tracking for supply rail sequencing.

Fault protection features include foldback current protection, thermal shutdown and a programmable soft-start function. The LTM4604 is offered in a RoHS compliant 15mm \times 9mm \times 2.32mm LGA package.

All registered trademarks and trademarks are the property of their respective owners.

TYPICAL APPLICATION

3.3V to 2.5V/4A μ Module Regulator

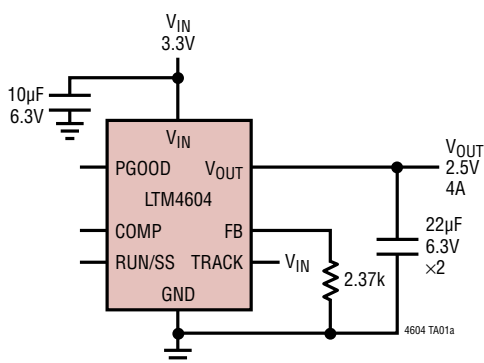

Efficiency vs Output Current

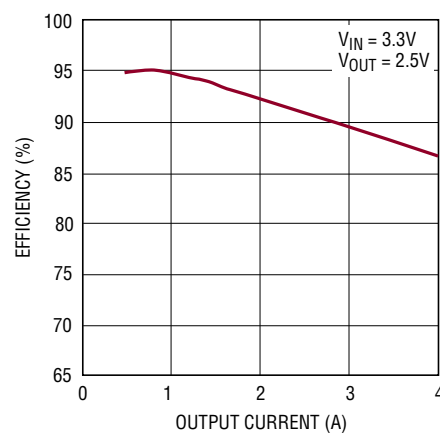

ABSOLUTE MAXIMUM RATINGS

(Note 1)

V_{IN} , PGOOD	-0.3V to 6V
COMP, RUN/SS, FB, TRACK.....	-0.3V to V_{IN}
SW, V_{OUT}	-0.3V to ($V_{IN} + 0.3V$)
Operating Temperature Range (Note 2)....	-40°C to 85°C
Junction Temperature	125°C
Storage Temperature Range	-55°C to 125°C
Reflow (Peak Body) Temperature.....	260°C

PIN CONFIGURATION

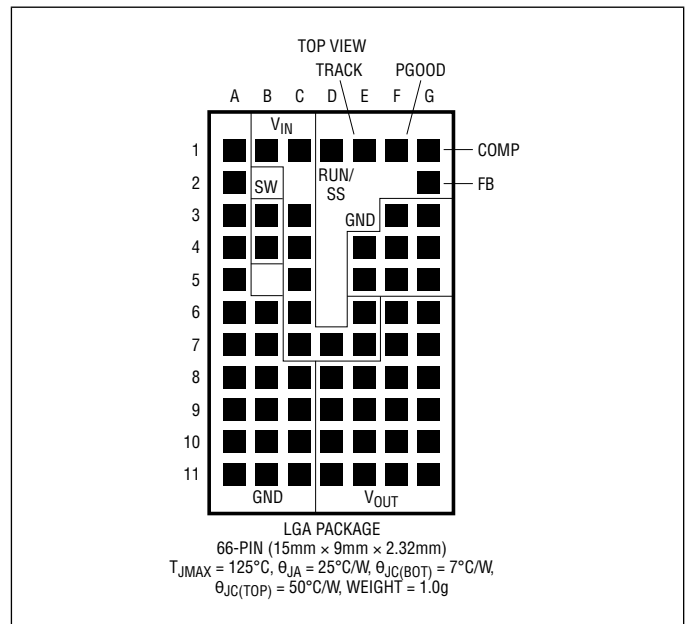

For easier PC board layout and assembly due to increased spacing between land grid pads, please refer to the LTM4604A.

ORDER INFORMATION

LEAD FREE FINISH	TRAY	PART MARKING*	PACKAGE TYPE	MSL RATING	TEMPERATURE RANGE (SEE NOTE 2)
LTM4604EV#PBF	LTM4604EV#PBF	LTM4604V	LGA	4	-40°C to 85°C
LTM4604IV#PBF	LTM4604EV#PBF	LTM4604V			

- Contact the factory for parts specified with wider operating temperature ranges. *Pad or ball finish code is per IPC/JEDEC J-STD-609.
- Device temperature grade is indicated by a label on the shipping container.
- [Recommended LGA and BGA PCB Assembly and Manufacturing Procedures](#)
- [LGA and BGA Package and Tray Drawings](#)

ELECTRICAL CHARACTERISTICS

The ● denotes the specifications which apply over the full operating temperature range (Note 2), otherwise specifications are at $T_A = 25^{\circ}\text{C}$. $V_{IN} = 5V$ unless otherwise noted. See Figure 15.

SYMBOL	PARAMETER	CONDITIONS	MIN	TYP	MAX	UNITS
$V_{IN(DC)}$	Input DC Voltage		● 2.375		5.5	V
$V_{OUT(DC)}$	Output Voltage, Total Variation with Line and Load	$C_{IN} = 10\mu\text{F}$, $C_{OUT} = 22\mu\text{F} \times 3$, $R_{FB} = 5.69k$ (Note 3) $V_{IN} = 2.375V$ to $5.5V$, $I_{OUT} = 0A$ to $4A$, $0^{\circ}\text{C} \leq T_A \leq 85^{\circ}\text{C}$ $V_{IN} = 2.375V$ to $5.5V$, $I_{OUT} = 0A$ to $4A$	● 1.478	1.5	1.522	V
			● 1.470	1.5	1.522	V
Input Specifications						
$V_{IN(UVLO)}$	Undervoltage Lockout Threshold	$I_{OUT} = 0A$	1.75	2	2.3	V
$I_{INRUSH(VIN)}$	Peak Input Inrush Current at Start-Up	$I_{OUT} = 0A$, $C_{IN} = 10\mu\text{F}$, $C_{OUT} = 22\mu\text{F} \times 3$, RUN/SS = $0.01\mu\text{F}$, $V_{OUT} = 1.5V$ $V_{IN} = 3.3V$ $V_{IN} = 5V$		0.7		A
				0.7		A
$I_{Q(VIN \text{ NOLOAD})}$	Input Supply Bias Current	$V_{IN} = 3.3V$, No Switching $V_{IN} = 3.3V$, $V_{OUT} = 1.5V$, Switching Continuous $V_{IN} = 5V$, No Switching $V_{IN} = 5V$, $V_{OUT} = 1.5V$, Switching Continuous Shutdown, RUN = 0, $V_{IN} = 5V$		60		μA
				28		mA
				100		μA
				35		mA
				7		μA

Rev. C

ELECTRICAL CHARACTERISTICS

The ● denotes the specifications which apply over the full operating temperature range (Note 2), otherwise specifications are at $T_A = 25^\circ\text{C}$. $V_{IN} = 5\text{V}$ unless otherwise noted. See Figure 15.

SYMBOL	PARAMETER	CONDITIONS	MIN	TYP	MAX	UNITS	
$I_{S(VIN)}$	Input Supply Current	$V_{IN} = 2.5\text{V}$, $V_{OUT} = 1.5\text{V}$, $I_{OUT} = 4\text{A}$		2.9		A	
		$V_{IN} = 3.3\text{V}$, $V_{OUT} = 1.5\text{V}$, $I_{OUT} = 4\text{A}$	●	2.2		A	
		$V_{IN} = 5\text{V}$, $V_{OUT} = 1.5\text{V}$, $I_{OUT} = 4\text{A}$		1.45		A	
Output Specifications							
$I_{OUT(DC)}$	Output Continuous Current Range	$V_{IN} = 3.3\text{V}$, $V_{OUT} = 1.5\text{V}$ (Note 3)			4	A	
$\frac{\Delta V_{OUT(LINE)}}{V_{OUT}}$	Line Regulation Accuracy	$V_{OUT} = 1.5\text{V}$, V_{IN} from 2.375V to 5.5V, $I_{OUT} = 0\text{A}$	●	0.1	0.2	%	
$\frac{\Delta V_{OUT(LOAD)}}{V_{OUT}}$	Load Regulation Accuracy	$V_{OUT} = 1.5\text{V}$, 0A to 4A (Note 3)	●	0.3	0.6	%	
		$V_{IN} = 3.3\text{V}$	●	0.3	0.6	%	
$V_{OUT(AC)}$	Output Ripple Voltage	$I_{OUT} = 0\text{A}$, $C_{OUT} = 22\mu\text{F X5R Ceramic} \times 3$		10		mV _{p-p}	
		$V_{IN} = 3.3\text{V}$, $V_{OUT} = 1.5\text{V}$		12		mV _{p-p}	
f_S	Output Ripple Voltage Frequency	$I_{OUT} = 4\text{A}$, $V_{IN} = 5\text{V}$, $V_{OUT} = 1.5\text{V}$		1.25		MHz	
$\Delta V_{OUT(START)}$	Turn-On Overshoot	$C_{OUT} = 22\mu\text{F} \times 3$, $V_{OUT} = 1.5\text{V}$, RUN/SS = 10nF, $I_{OUT} = 0\text{A}$		20		mV	
t_{START}	Turn-on Time	$V_{IN} = 3.3\text{V}$		20		mV	
		$V_{IN} = 5\text{V}$		20		mV	
$\Delta V_{OUT(LS)}$	Peak Deviation for Dynamic Load Step	$C_{OUT} = 22\mu\text{F} \times 3$, $V_{OUT} = 1.5\text{V}$, $I_{OUT} = 1\text{A}$ Resistive Load, TRACK = V_{IN} and RUN/SS = Float		1.5		ms	
		$V_{IN} = 3.3\text{V}$		1.0		ms	
t_{SETTLE}	Settling Time for Dynamic Load Step	$V_{IN} = 5\text{V}$, $V_{OUT} = 1.5\text{V}$		25		mV	
		Load: 0% to 50% to 0% of Full Load, $C_{OUT} = 22\mu\text{F} \times 3$ Ceramic, $V_{IN} = 5\text{V}$, $V_{OUT} = 1.5\text{V}$		10		μs	
$I_{OUT(PK)}$	Output Current Limit	$C_{OUT} = 22\mu\text{F} \times 3$		8		A	
		$V_{IN} = 3.3\text{V}$, $V_{OUT} = 1.5\text{V}$		8		A	
V_{FB}	Voltage at FB Pin	$I_{OUT} = 0\text{A}$, $V_{OUT} = 1.5\text{V}$, $0^\circ\text{C} \leq T_A \leq 85^\circ\text{C}$	●	0.792	0.8	0.808	V
		$I_{OUT} = 0\text{A}$, $V_{OUT} = 1.5\text{V}$		0.788	0.8	0.812	V
I_{FB}				0.2		μA	
$V_{RUN/SS}$	RUN/SS Pin On/Off Threshold		0.5	0.65	0.8	V	
I_{TRACK}	TRACK Pin Current			0.2		μA	
$V_{TRACK(OFFSET)}$	Offset Voltage	TRACK = 0.4V		30		mV	
$V_{TRACK(RANGE)}$	Tracking Input Range		0		0.8	V	
R_{FBHI}	Resistor Between V_{OUT} and FB Pins		4.965	4.99	5.015	k Ω	
PGOOD							
ΔV_{PGOOD}	PGOOD Range			± 7.5		%	
R_{PGOOD}	PGOOD Resistance	Open-Drain Pull-Down		90	150	Ω	

Note 1: Stresses beyond those listed under Absolute Maximum Ratings may cause permanent damage to the device. Exposure to any Absolute Maximum Rating condition for extended periods may affect device reliability and lifetime.

Note 2: The LTM4604E is guaranteed to meet performance specifications from 0°C to 85°C . Specifications over the -40°C to 85°C operating temperature range are assured by design, characterization and correlation

with statistical process controls. The LTM4604I is guaranteed over the full -40°C to 85°C operating temperature range.

Note 3: See output current derating curves for different V_{IN} , V_{OUT} and T_A .

TYPICAL PERFORMANCE CHARACTERISTICS

Efficiency vs Output Current
 $V_{IN} = 2.5V$

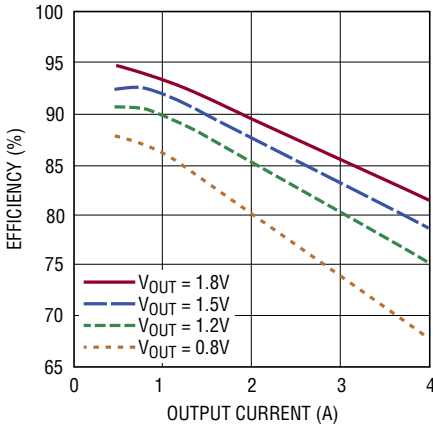

4604 G01

Efficiency vs Output Current
 $V_{IN} = 3.3V$

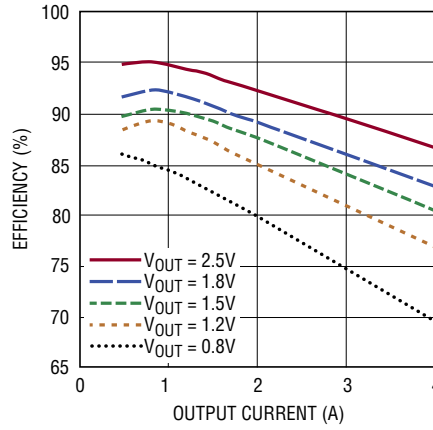

4604 G02

Efficiency vs Output Current
 $V_{IN} = 5V$

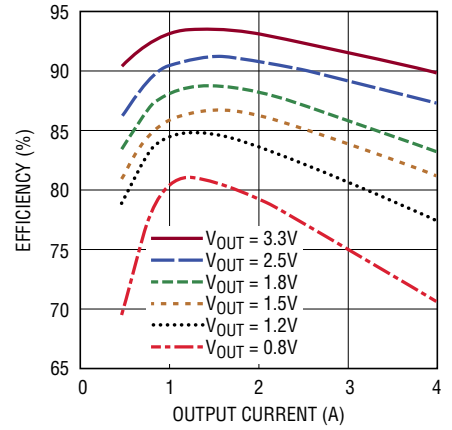

4604 G03

Minimum Input Voltage at 4A Load

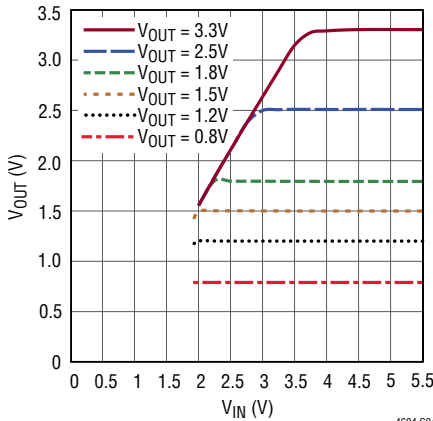

4604 G04

Load Transient Response

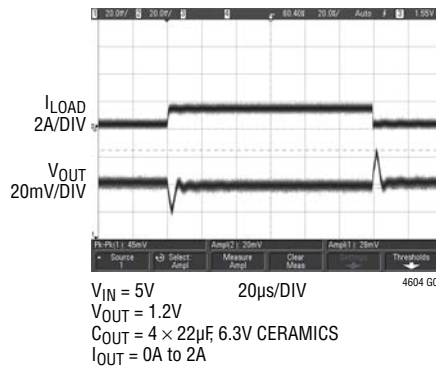

4604 G05

Load Transient Response

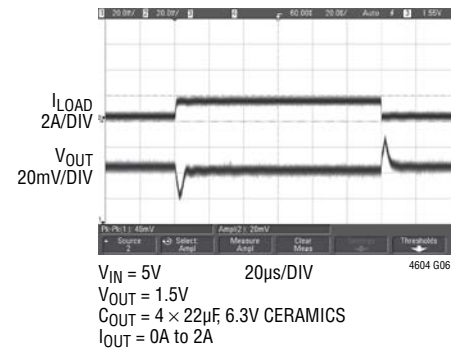

4604 G06

Load Transient Response

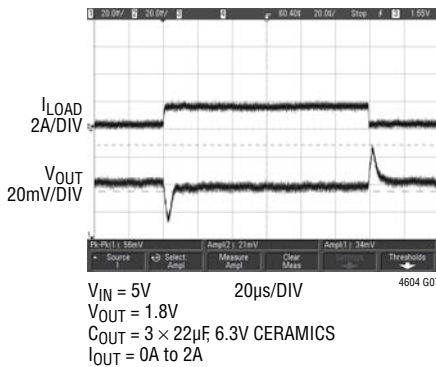

4604 G07

Load Transient Response

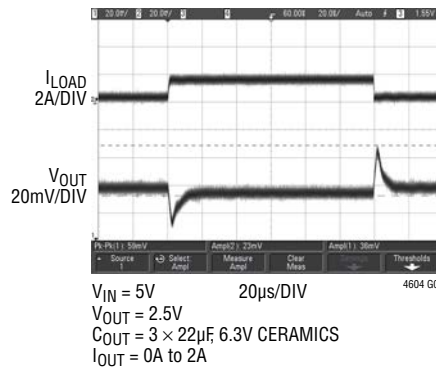

4604 G08

Load Transient Response

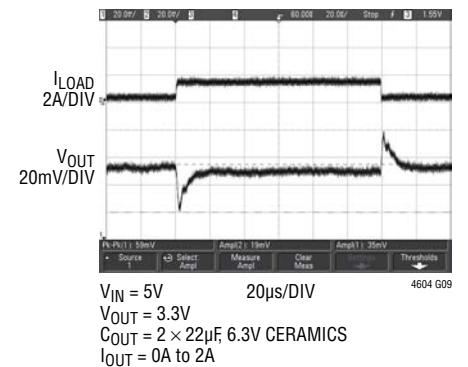

4604 G09

TYPICAL PERFORMANCE CHARACTERISTICS

Start-Up

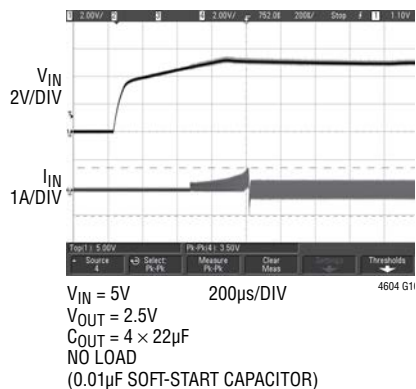

Start-Up

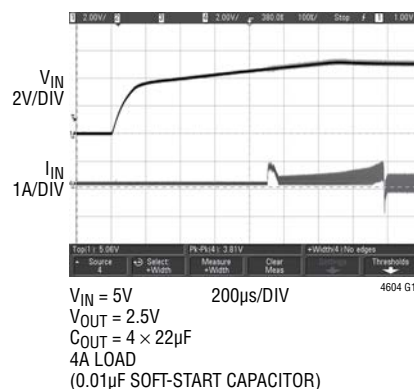

V_{FB} vs Temperature

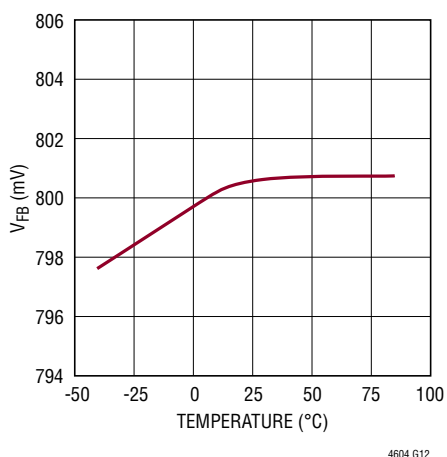

Current Limit Foldback

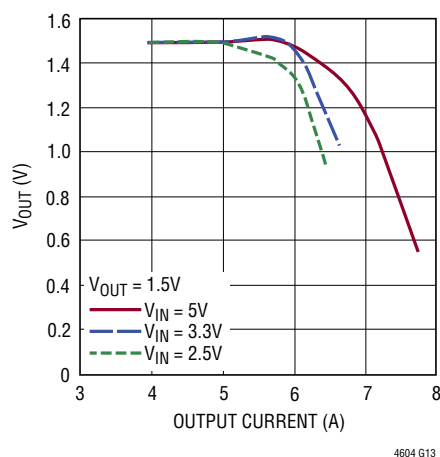

**Short-Circuit Protection
1.5V Short, No Load**

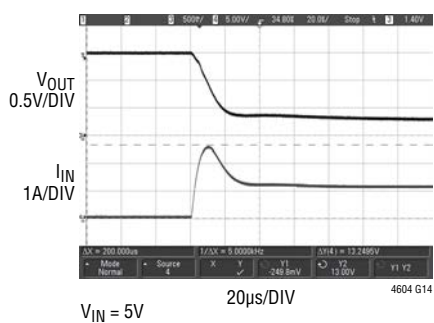

**Short-Circuit Protection
1.5V Short, 4A Load**

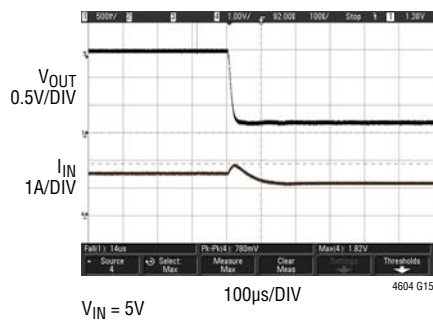

PIN FUNCTIONS

V_{IN} (B1, C1, C3-C7, D7, E6 and E7): Power Input Pins. Apply input voltage between these pins and GND pins. Recommend placing input decoupling capacitance directly between V_{IN} pins and GND pins.

V_{OUT} (D8-D11, E8-E11, F6-F11, G6-G11): Power Output Pins. Apply output load between these pins and GND pins. Recommend placing output decoupling capacitance directly between these pins and GND pins. Review Table 4.

GND (G3-G5, F3-F5, E4-E5, A1-A11, B6-B11, C8-C11): Power Ground Pins for Both Input and Output Returns.

TRACK (E1): Output Voltage Tracking Pin. When the module is configured as a master output, then a soft-start capacitor is placed on the RUN/SS pin to ground to control the master ramp rate. Slave operation is performed by putting a resistor divider from the master output to ground, and connecting the center point of the divider to this pin on the slave regulator. If tracking is not desired, then connect the TRACK pin to V_{IN}. Load current must be present for tracking. See Applications Information section.

FB (G2): The Negative Input of the Error Amplifier. Internally, this pin is connected to V_{OUT} with a 4.99k precision resistor. Different output voltages can be programmed with an externally connected resistor between FB and GND pins. Two power modules can current share

when this pin is connected in parallel with the adjacent module's FB pin. See Applications Information section.

COMP (G1): Current Control Threshold and Error Amplifier Compensation Point. The current comparator threshold increases with this control voltage. Two power modules can current share when this pin is connected in parallel with the adjacent module's COMP pin.

PGOOD (F1): Output Voltage Power Good Indicator. Open-drain logic output that is pulled to ground when the output voltage is not within $\pm 7.5\%$ of the regulation point.

RUN/SS (D1): Run Control and Soft-Start Pin. A voltage above 0.8V will turn on the module, and below 0.5V will turn off the module. This pin has a 1M resistor to V_{IN} and a 1000pF capacitor to GND. The voltage on the RUN/SS pin clamps the control loop's current comparator threshold. A RUN/SS pin voltage of 2.375V upon completion of soft-start guarantees the regulator can deliver full output current. To turn off the module while V_{IN} remains active, the RUN/SS pin should be pulled low with a falling edge $\leq 1\mu\text{s}$ to ensure the device does not transition slowly through the internal undervoltage lockout threshold. See Applications Information section for soft-start information.

SW (B3 and B4): Switching Node of the circuit is used for testing purposes. This can be connected to copper on the board to improve thermal performance. Make sure not to connect it to other output pins.

OPERATION

Power Module Description

The LTM4604 is a standalone non-isolated switch mode DC/DC power supply. It can deliver up to 4A of DC output current with few external input and output capacitors. This module provides a precise regulated output voltage programmable via one external resistor from 0.8V DC to 5.0V DC over a 2.375V to 5.5V input voltage. A typical application schematic is shown in Figure 15.

The LTM4604 has an integrated constant frequency current mode regulator with built-in power MOSFETs with fast switching speed. The typical switching frequency is 1.25MHz. With current mode control and internal feedback loop compensation, the LTM4604 module has sufficient stability margins and good transient performance under a wide range of operating conditions and with a wide range of output capacitors, even all ceramic output capacitors.

Current mode control provides cycle-by-cycle fast current limit. In addition, foldback current limiting is provided in an overcurrent condition while V_{OUT} drops.

Internal overvoltage and undervoltage comparators pull the open-drain PGOOD output low if the output feedback voltage exits a $\pm 7.5\%$ window around the regulation point. Furthermore, in an overvoltage condition, internal top FET M1 is turned off and bottom FET M2 is turned on and held on until the overvoltage condition clears.

Pulling the RUN/SS pin below 0.5V forces the controller into its shutdown state, turning off both M1 and M2. At low load current, the module works in continuous current mode by default to achieve minimum output voltage ripple.

The TRACK pin is used for power supply tracking. See the Applications Information section.

The LTM4604 is internally compensated to be stable over a wide operating range. Table 4 provides a guideline for input and output capacitance for several operating conditions. The LTpowerCAD™ GUI is available for transient and stability analysis.

The FB pin is used to program the output voltage with a single external resistor connected to ground.

APPLICATIONS INFORMATION

A typical LTM4604 application circuit is shown in Figure 15. External component selection is primarily determined by the maximum load current and output voltage. Refer to Table 4 for specific external capacitor requirements for a particular application.

V_{IN} to V_{OUT} Step-Down Ratios

There are restrictions in the maximum V_{IN} and V_{OUT} step-down ratio that can be achieved for a given input voltage. The LTM4604 is 100% duty cycle capable, but the V_{IN} to V_{OUT} minimum dropout is a function of the load current. A typical 0.5V minimum is sufficient (see Typical Performance Characteristics).

Output Voltage Programming

The PWM controller has an internal 0.8V reference voltage. As shown in the Block Diagram, a 4.99k, 0.5% internal feedback resistor connects the V_{OUT} and FB pins together. The output voltage will default to 0.8V with no externally applied feedback resistor. Adding a resistor R_{FB} from the FB pin to GND programs the output voltage:

$$V_{OUT} = 0.8V \cdot \frac{4.99k + R_{FB}}{R_{FB}}$$

Table 1. FB Resistor vs Output Voltage

V_{OUT}	0.8V	1.0V	1.2V	1.5V	1.8V	2.5V	3.3V
R_{FB}	Open	20k	10k	5.76k	4.02k	2.37k	1.62k

Input Capacitors

The LTM4604 module should be connected to a low AC-impedance DC source. Two 10 μ F ceramic capacitors are included inside the module. Additional input capacitors are only needed if a large load step is required up to a full 4A level. An input 47 μ F bulk capacitor is only needed if the input source impedance is compromised by long inductive leads or traces.

For a buck converter, the switching duty cycle can be estimated as:

$$D = \frac{V_{OUT}}{V_{IN}}$$

Without considering the inductor current ripple, the RMS current of the input capacitor can be estimated as:

$$I_{CIN(RMS)} = \frac{I_{OUT(MAX)}}{\eta\%} \cdot \sqrt{D \cdot (1-D)}$$

In the above equation, $\eta\%$ is the estimated efficiency of the power module. The bulk capacitor can be a switcher-rated aluminum electrolytic capacitor, OS-CON or polymer capacitor. If a low inductance plane is used to power the device, then no input capacitance is required. The two internal 10 μ F ceramics are typically rated for 2A to 3A of RMS ripple current. The worst-case ripple current for the 4A maximum current is 2A or less.

Output Capacitors

The LTM4604 is designed for low output voltage ripple. The bulk output capacitors defined as C_{OUT} are chosen with low enough effective series resistance (ESR) to meet the output voltage ripple and transient requirements. C_{OUT} can be a low ESR tantalum capacitor, a low ESR polymer capacitor or an X5R/X7R ceramic capacitor. The typical output capacitance range is 22 μ F to 100 μ F. Additional output filtering may be required by the system designer if further reduction of output ripple or dynamic transient spikes is required. Table 4 shows a matrix of different output voltages and output capacitors to minimize the voltage droop and overshoot during a 2A/ μ s transient. The table optimizes the total equivalent ESR and total bulk capacitance to maximize transient performance. The LTpowerCAD GUI is available for further optimization.

Fault Conditions: Current Limit and Overcurrent Foldback

The LTM4604 has current mode control, which inherently limits the cycle-by-cycle inductor current not only in steady-state operation, but also in transient.

To further limit current in the event of an overload condition, the LTM4604 provides foldback current limiting as the output voltage falls. The LTM4604 device has over-temperature shutdown protection that inhibits switching operation around 150°C.

APPLICATIONS INFORMATION

Run Enable and Soft-Start

The RUN/SS pin provides dual functions of enable and soft-start control. The RUN/SS pin is used to control turn on of the LTM4604. While this pin is below 0.5V, the LTM4604 will be in a 7µA low quiescent current state. A 0.8V threshold will enable the LTM4604. This pin can be used to sequence LTM4604 devices. The voltage on the RUN/SS pin clamps the control loop's current comparator threshold. A RUN/SS pin voltage of 2.375V upon completion of soft-start guarantees the regulator can deliver full output current. The soft-start control is provided by a 1M pull-up resistor (R_{SS}) and a 1000pF capacitor (C_{SS}) as shown in the Block Diagram. An external capacitor can be applied to the RUN/SS pin to increase the soft-start time. A typical value is 0.01µF. Soft-start time is approximately given by:

$$t_{SOFTSTART} = \ln\left(\frac{V_{IN}}{V_{IN} - 1.8V}\right) \cdot R_{SS} (C_{SS} + C_{SSEXT})$$

where R_{SS} and C_{SS} are shown in the Block Diagram of Figure 1, 1.8V is the soft-start upper range, and C_{SSEXT} is the additional capacitance for further soft-start control. The soft-start function can also be used to control the output ramp-up time, so that another regulator can be easily tracked. An independent ramp control signal can be applied to the master ramp, otherwise, connect the TRACK pin to V_{IN} to disable tracking. To turn off the module while V_{IN} remains active, the RUN/SS pin should be pulled low with a falling edge $\leq 1\mu s$ to ensure the device does not transition slowly through the internal undervoltage lockout threshold.

Output Voltage Tracking

Output voltage tracking can be programmed externally using the TRACK pin. The output can be tracked up and down with another regulator. The master regulator's output is divided down with an external resistor divider that is the same as the slave regulator's feedback divider to implement coincident tracking. The LTM4604 uses a very accurate 4.99k resistor for the top feedback resistor. Figure 2 and Figure 3 show an example of coincident tracking.

$$V_{TRACK} = \frac{R_{FB2}}{4.99k + R_{FB2}} \cdot V_{MASTER}$$

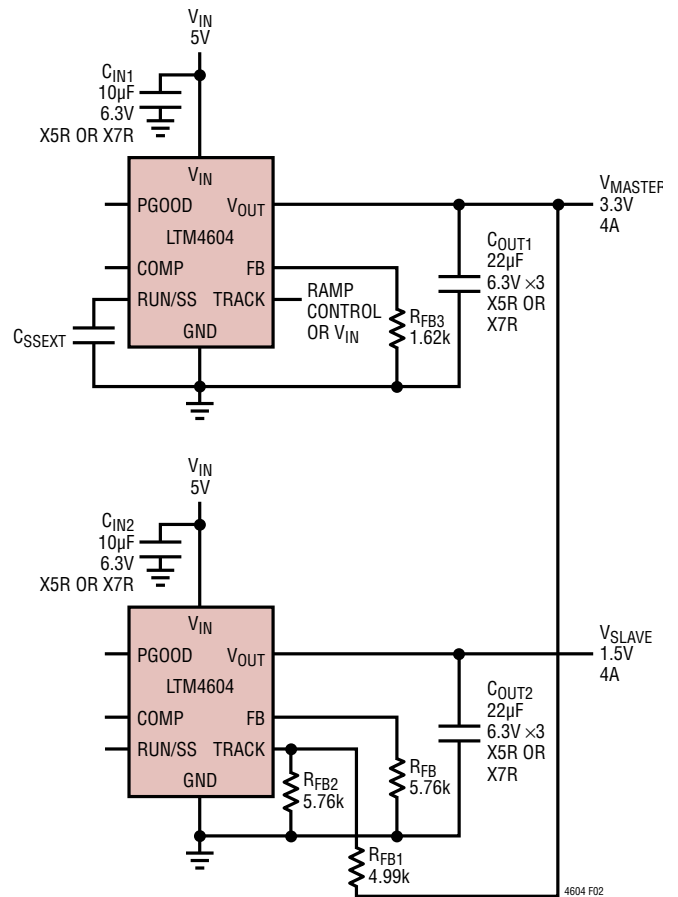

Figure 2. Dual Outputs (3.3V and 1.5V) with Tracking

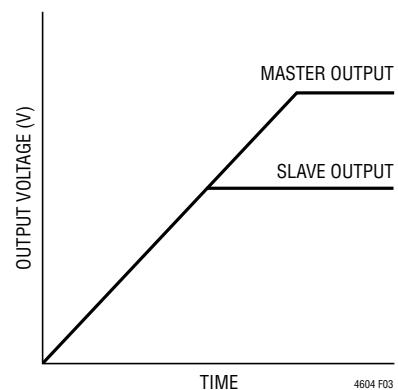

Figure 3. Output Voltage Coincident Tracking

APPLICATIONS INFORMATION

V_{TRACK} is the track ramp applied to the slave's TRACK pin. V_{TRACK} applies the track reference for the slave output up to the point of the programmed value at which V_{TRACK} proceeds beyond the 0.8V reference value. The V_{TRACK} pin must go beyond 0.8V to ensure the slave output has reached its final value. Load current must be present for proper tracking.

Ratiometric modes of tracking can be achieved by selecting different resistor values to change the output tracking ratio. The master output must be greater than the slave output for ratiometric tracking to work. LTspice® can be used to implement different tracking scenarios. The Master and Slave data inputs can be used to implement the correct resistor values for coincident or ratiometric tracking. The master and slave regulators require load current for tracking down.

Power Good

The PGOOD pin is an open-drain pin that can be used to monitor valid output voltage regulation. This pin monitors a $\pm 7.5\%$ window around the regulation point.

COMP Pin

The COMP pin is the external compensation pin. The LTM4604 has already been internally compensated for all output voltages. Table 4 is provided for most application requirements. The LTpowerCAD GUI is available for other control loop optimizations.

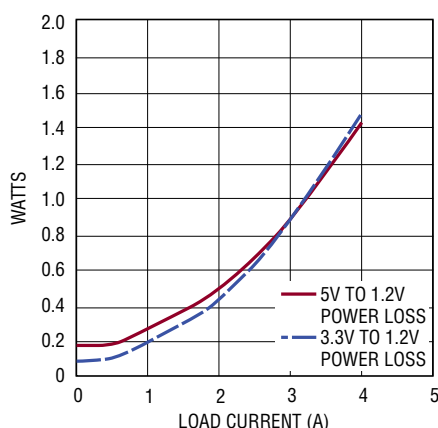

Figure 4. 1.2V Power Loss

Parallel Operation

The LTM4604 device is an inherently current mode controlled device. Parallel modules will have very good current sharing. This will balance the thermals on the design. Figure 16 shows a schematic of the parallel design. The voltage feedback changes with the variable N as more modules are paralleled. The equation:

$$V_{OUT} = 0.8V \cdot \frac{\frac{4.99k}{N} + R_{FB}}{R_{FB}}$$

N is the number of paralleled modules.

Thermal Considerations and Output Current Derating

The power loss curves in Figure 4 and Figure 5 can be used in coordination with the load derating curves in Figure 6 through Figure 13 for calculating an approximate θ_{JA} for the module with and without heat sinking methods with various airflow conditions. Thermal models are derived from several temperature measurements at the bench, and are correlated with thermal analysis software. Table 2 and Table 3 provide a summary of the equivalent θ_{JA} for the noted conditions. These equivalent θ_{JA} parameters are correlated to the measured values and improve with air flow. The maximum junction temperature is monitored while the derating curves are derived.

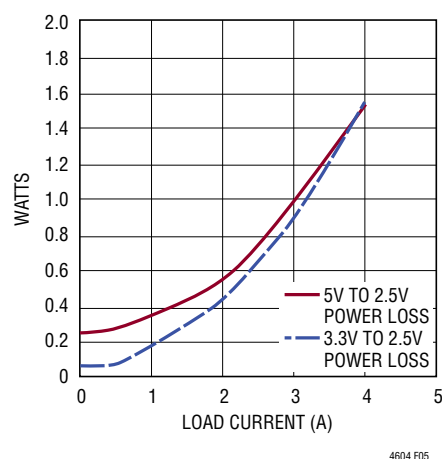
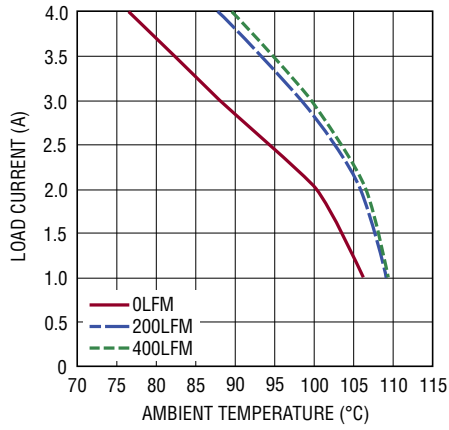

Figure 5. 2.5V Power Loss

APPLICATIONS INFORMATION



4606 F06

Figure 6. 5V_{IN} to 1.2V_{OUT} No Heat Sink

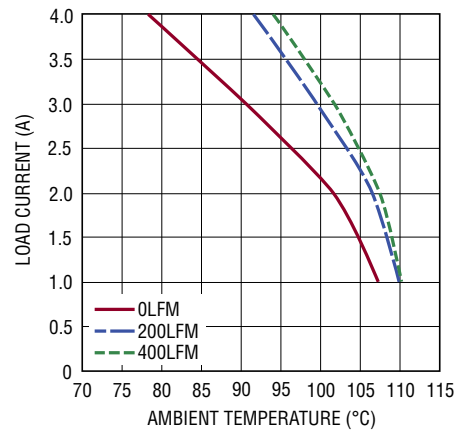

4606 F07

Figure 7. 5V_{IN} to 1.2V_{OUT} with Heat Sink

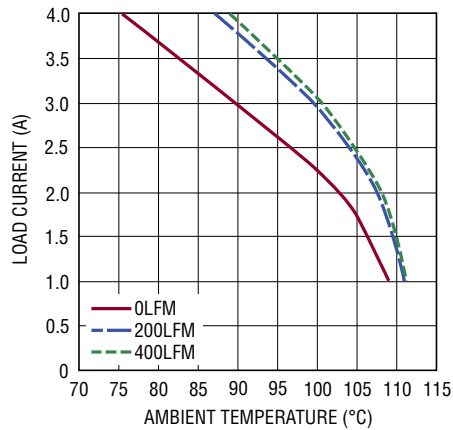

4606 F08

Figure 8. 3.3V_{IN} to 1.2V_{OUT} No Heat Sink

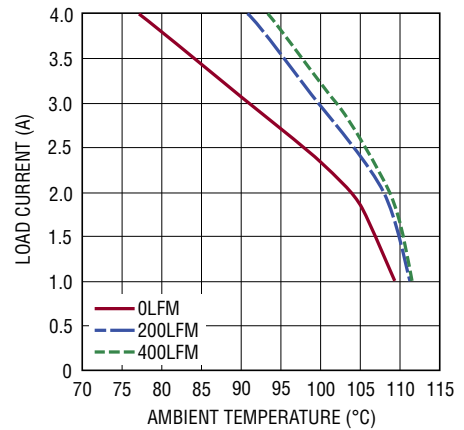

4606 F09

Figure 9. 3.3V_{IN} to 1.2V_{OUT} with Heat Sink

APPLICATIONS INFORMATION

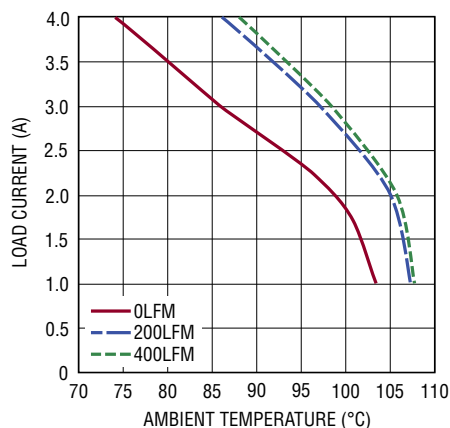

4606 F10

Figure 10. 5V_{IN} to 2.5V_{OUT} No Heat Sink

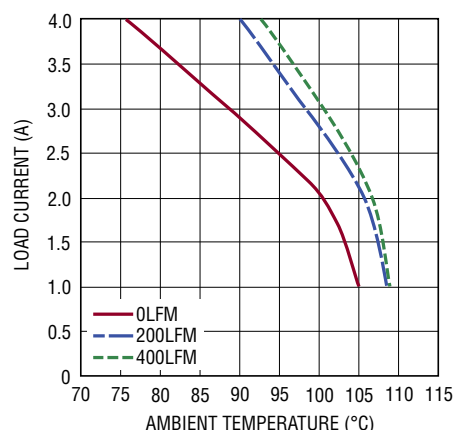

4606 F11

Figure 11. 5V_{IN} to 2.5V_{OUT} with Heat Sink

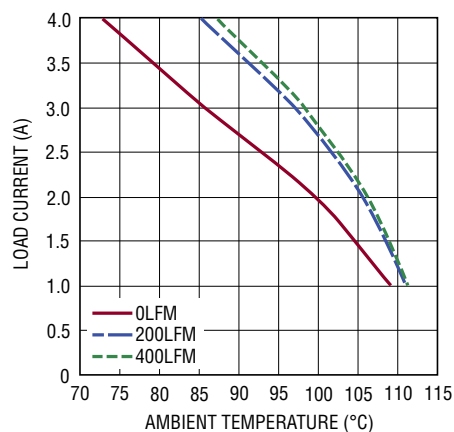

4606 F12

Figure 12. 3.3V_{IN} to 2.5V_{OUT} No Heat Sink

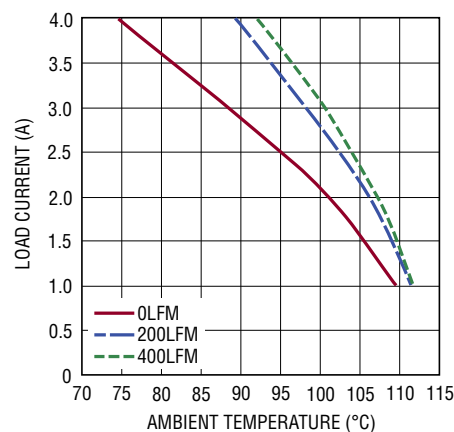

4606 F13

Figure 13. 3.3V_{IN} to 2.5V_{OUT} with Heat Sink

APPLICATIONS INFORMATION

Table 2. 1.2V Output

DERATING CURVE	V _{IN} (V)	POWER LOSS CURVE	AIR FLOW (LFM)	HEAT SINK	θ _{JA} (°C/W)
Figure 6, Figure 8	3.3, 5	Figure 4	0	None	25
Figure 6, Figure 8	3.3, 5	Figure 4	200	None	22.5
Figure 6, Figure 8	3.3, 5	Figure 4	400	None	21
Figure 7, Figure 9	3.3, 5	Figure 4	0	BGA Heat Sink	21
Figure 7, Figure 9	3.3, 5	Figure 4	200	BGA Heat Sink	20
Figure 7, Figure 9	3.3, 5	Figure 4	400	BGA Heat Sink	18

Table 3. 2.5V Output

DERATING CURVE	V _{IN} (V)	POWER LOSS CURVE	AIR FLOW (LFM)	HEAT SINK	θ _{JA} (°C/W)
Figure 10, Figure 12	3.3, 5	Figure 5	0	None	25
Figure 10, Figure 12	3.3, 5	Figure 5	200	None	21
Figure 10, Figure 12	3.3, 5	Figure 5	400	None	21
Figure 11, Figure 13	3.3, 5	Figure 5	0	BGA Heat Sink	21
Figure 11, Figure 13	3.3, 5	Figure 5	200	BGA Heat Sink	18
Figure 11, Figure 13	3.3, 5	Figure 5	400	BGA Heat Sink	16

Table 4. Output Voltage Response Versus Component Matrix (Refer to Figure 17), 0A to 2A Load Step Typical Measured Values

V _{OUT} (V)	C _{IN} (CERAMIC)	C _{IN} (Bulk)	C _{OUT} (CERAMIC)	C _{COMP}	V _{IN} (V)	DROOP (mV)	PEAK-TO-PEAK (mV)	RECOVERY (μs)	LOAD STEP (A/μs)	R _{FB} (kΩ)
1.2	10μF	56μF Aluminum	100μF 6.3V	None	2.5	21	43	10	2	10
1.2	10μF	56μF Aluminum	22μF ×4	None	3.3	23	45	10	2	10
1.2	10μF	56μF Aluminum	22μF ×4	None	5	24	46	10	2	10
1.5	10μF	56μF Aluminum	100μF 6.3V	None	2.5	19	41	10	2	5.76
1.5	10μF	56μF Aluminum	22μF ×4	None	3.3	21	43	10	2	5.76
1.5	10μF	56μF Aluminum	22μF ×4	None	5	21	43	10	2	5.76
1.8	10μF	56μF Aluminum	100μF 6.3V	None	2.5	25	50	10	2	4.02
1.8	10μF	56μF Aluminum	22μF ×3	None	3.3	30	60	10	2	4.02
1.8	10μF	56μF Aluminum	22μF ×3	None	5	30	60	10	2	4.02
2.5	10μF	56μF Aluminum	100μF 6.3V	None	2.5	22	45	12	2	2.37
2.5	10μF	56μF Aluminum	22μF ×3	None	3.3	25	55	12	2	2.37
2.5	10μF	56μF Aluminum	22μF ×3	None	5	25	55	12	2	2.37
3.3	10μF	56μF Aluminum	100μF 6.3V	None	2.5	22	50	15	2	1.62
3.3	10μF	56μF Aluminum	22μF ×3	None	3.3	25	56	15	2	1.62
3.3	10μF	56μF Aluminum	22μF ×3	None	5	25	56	15	2	1.62

APPLICATIONS INFORMATION

Safety Considerations

The LTM4604 μ Module regulator does not provide galvanic isolation from V_{IN} to V_{OUT} . There is no internal fuse. If required, a slow blow fuse with a rating twice the maximum input current needs to be provided to protect each unit from catastrophic failure.

Layout Checklist/Example

The high integration of LTM4604 makes the PCB board layout very simple and easy. However, to optimize its electrical and thermal performance, some layout considerations are still necessary.

- Use large PCB copper areas for high current path, including V_{IN} , GND and V_{OUT} . It helps to minimize the PCB conduction loss and thermal stress.
- Place high frequency ceramic input and output capacitors next to the V_{IN} , GND and V_{OUT} pins to minimize high frequency noise.
- Place a dedicated power ground layer underneath the unit.
- To minimize the via conduction loss and reduce module thermal stress, use multiple vias for interconnection between top layer and other power layers.

- Do not put vias directly on the pads unless they are capped.
- SW pads can be soldered to board to improve thermal performance.

Figure 14 gives a good example of the recommended layout. **For easier PC board layout and assembly due to increased spacing between land grid pads, please refer to the LTM4604A.**

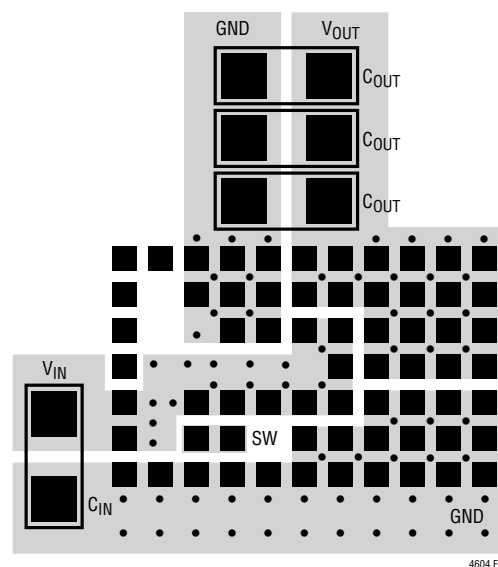

Figure 14. Recommended PCB Layout

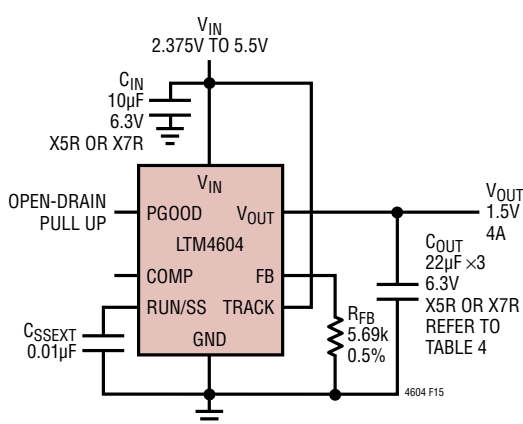

Figure 15. Typical 2.375V to 5.5V Input, 1.5V at 4A Design

TYPICAL APPLICATIONS

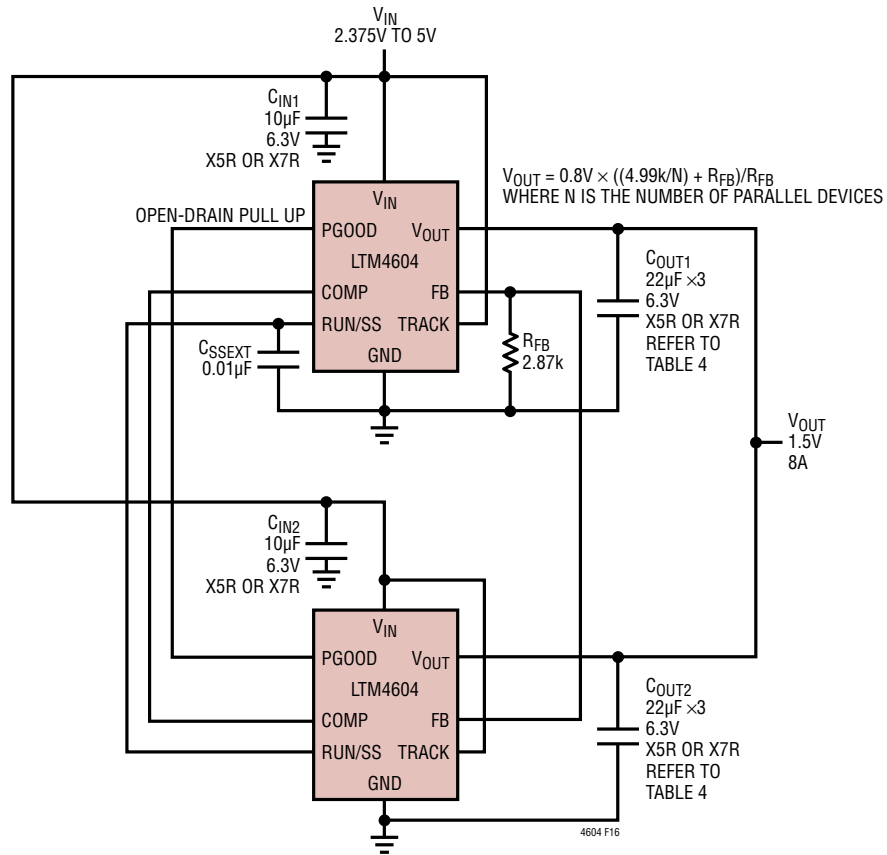

Figure 16. Two LTM4604s in Parallel, 1.5V at 8A Design. Also See the 8A LTM4608A or Dual 4A per Channel LTM4614

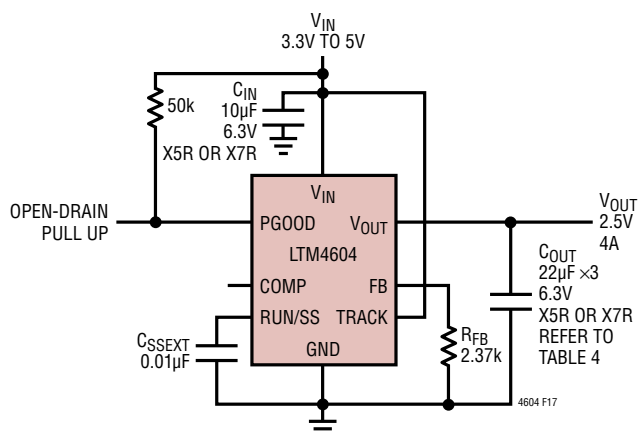
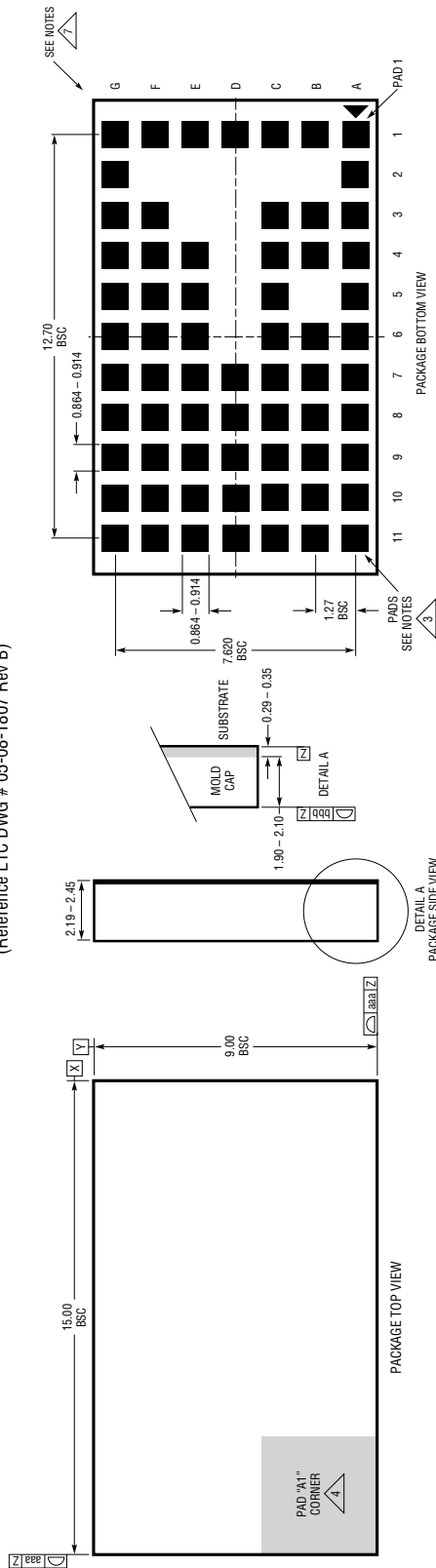

Figure 17. 3.3V to 5V Input, 2.5V at 4A Design

PACKAGE DESCRIPTION

LGA Package
66-Lead (15mm × 9mm × 2.32mm)
 (Reference LTC DWG # 05-08-1807 Rev B)



- NOTES:**
1. DIMENSIONING AND TOLERANCING PER ASME Y14.5M-1994
 2. ALL DIMENSIONS ARE IN MILLIMETERS
 3. LAND DESIGNATION PER JEDEC MO-222
 4. DETAILS OF PAD #1 IDENTIFIER ARE OPTIONAL, BUT MUST BE LOCATED WITHIN THE ZONE INDICATED. THE PAD #1 IDENTIFIER MAY BE EITHER A MOLD OR A MARKED FEATURE
 5. PRIMARY DATUM -Z- IS SEATING PLANE
 6. THE TOTAL NUMBER OF PADS: 66
 7. PACKAGE ROW AND COLUMN LABELING MAY VARY AMONG μModule PRODUCTS. REVIEW EACH PACKAGE LAYOUT CAREFULLY

SYMBOL	TOLERANCE
aaa	0.15
bbb	0.10

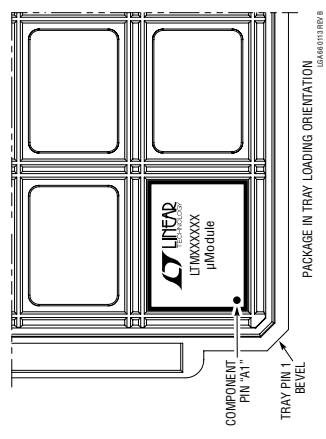
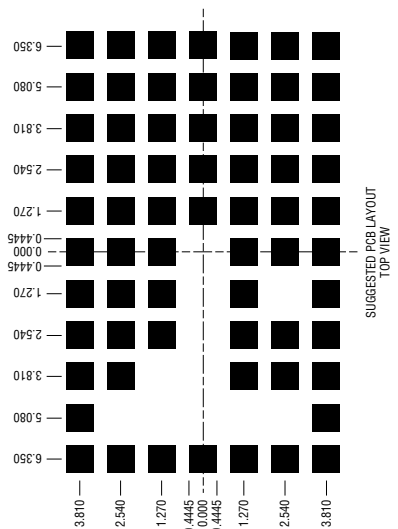

PACKAGE DESCRIPTION

**Pin Assignment Table
(Arranged by Pin Number)**

PIN ID	FUNCTION	PIN ID	FUNCTION	PIN ID	FUNCTION	PIN ID	FUNCTION
A1	GND	B1	V _{IN}	C1	V _{IN}	D1	RUN/SS
A2	GND	B2	–	C2	–	D2	–
A3	GND	B3	SW	C3	V _{IN}	D3	–
A4	GND	B4	SW	C4	V _{IN}	D4	–
A5	GND	B5	–	C5	V _{IN}	D5	–
A6	GND	B6	GND	C6	V _{IN}	D6	–
A7	GND	B7	GND	C7	V _{IN}	D7	V _{IN}
A8	GND	B8	GND	C8	GND	D8	V _{OUT}
A9	GND	B9	GND	C9	GND	D9	V _{OUT}
A10	GND	B10	GND	C10	GND	D10	V _{OUT}
A11	GND	B11	GND	C11	GND	D11	V _{OUT}

PIN ID	FUNCTION	PIN ID	FUNCTION	PIN ID	FUNCTION
E1	TRACK	F1	PGOOD	G1	COMP
E2	–	F2	–	G2	FB
E3	–	F3	GND	G3	GND
E4	GND	F4	GND	G4	GND
E5	GND	F5	GND	G5	GND
E6	V _{IN}	F6	V _{OUT}	G6	V _{OUT}
E7	V _{IN}	F7	V _{OUT}	G7	V _{OUT}
E8	V _{OUT}	F8	V _{OUT}	G8	V _{OUT}
E9	V _{OUT}	F9	V _{OUT}	G9	V _{OUT}
E10	V _{OUT}	F10	V _{OUT}	G10	V _{OUT}
E11	V _{OUT}	F11	V _{OUT}	G11	V _{OUT}

REVISION HISTORY

REV	DATE	DESCRIPTION	PAGE NUMBER
A	05/10	Updated Front Page Text	1
		Updated Absolute Maximum Ratings and Pin Configuration Section	2
		Updated Callouts on Graphs	5
		Added text to Layout Checklist/Example Section	15
		Updated Figure 16 Title	15
B	05/14	Updated thermal resistance and weight	2
		Updated Minimum Input Voltage graph	4
		Added output current information to Load Transient Response curves	4
		Updated RUN/SS Pin Description	6
		Updated Run Enable and Soft-Start section	10
C	04/21	Changed peak reflow to 260	2
		Added MSL 4 to Order Information table	2

DESIGN RESOURCES

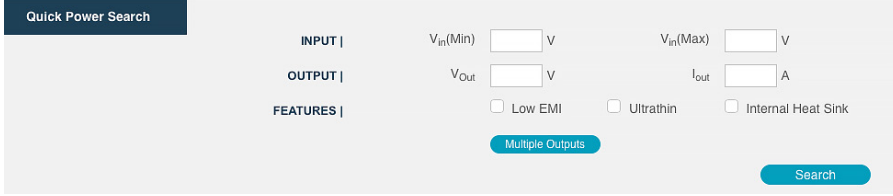
SUBJECT	DESCRIPTION
μModule Design and Manufacturing Resources	<p>Design:</p> <ul style="list-style-type: none"> • Selector Guides • Demo Boards and Gerber Files • Free Simulation Tools <p>Manufacturing:</p> <ul style="list-style-type: none"> • Quick Start Guide • PCB Design, Assembly and Manufacturing Guidelines • Package and Board Level Reliability
μModule Regulator Products Search	<ol style="list-style-type: none"> 1. Sort table of products by parameters and download the result as a spread sheet. 2. Search using the Quick Power Search parametric table. 
Digital Power System Management	Analog Devices' family of digital power supply management ICs are highly integrated solutions that offer essential functions, including power supply monitoring, supervision, margining and sequencing, and feature EEPROM for storing user configurations and fault logging.

RELATED PARTS

PART NUMBER	DESCRIPTION	COMMENTS
LTC2900	Quad Supply Monitor with Adjustable Reset Timer	Monitors Four Supplies; Adjustable Reset Timer
LTC2923	Power Supply Tracking Controller	Tracks Both Up and Down; Power Supply Sequencing
LTM4600	10A DC/DC μModule Regulator	Basic 10A DC/DC μModule Regulator
LTM4601	12A DC/DC μModule Regulator with PLL, Output Tracking/ Margining and Remote Sensing	Synchronizable, PolyPhase Operation, LTM4601-1 Version has no Remote Sensing
LTM4602	6A DC/DC μModule Regulator	Pin Compatible with the LTM4600
LTM4603	6A DC/DC μModule Regulator with PLL and Output Tracking/Margining and Remote Sensing	Synchronizable, PolyPhase Operation, LTM4603-1 Version has no Remote Sensing, Pin Compatible with the LTM4601
LTM4608A	8A Low Voltage μModule Regulator	$2.375V \leq V_{IN} \leq 5V$, Parallel for Higher Output Current, 9mm × 15mm × 2.82mm

Mouser Electronics

Authorized Distributor

Click to View Pricing, Inventory, Delivery & Lifecycle Information:

[Analog Devices Inc.:](#)

[LTM4604IV#PBF](#) [LTM4604EV#PBF](#)