

Click to view price, real time Inventory,
Delivery & Lifecycle Information ;

LDLN025PU18R

STMicroelectronics

LDO Voltage Regulators 250 mA ultra-low noise LDO

Any questions, please feel free to contact us.

info@kaimte.com

250 mA ultra low noise LDO

Datasheet - production data

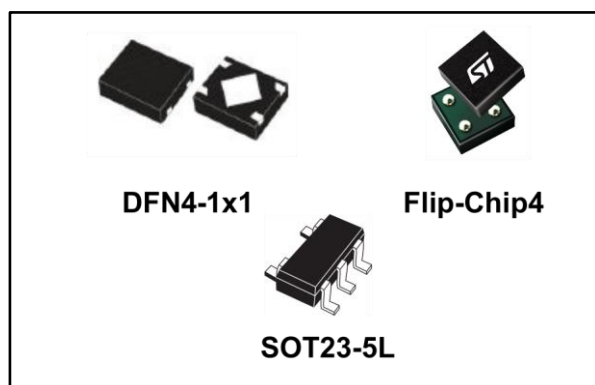
**Features**

- Ultra low output noise: 6.5 μV_{RMS}
- Operating input voltage range: 1.5 V to 5.5 V
- Output current up to 250 mA
- Very low quiescent current: 12 μA at no-load
- Controlled I_q in dropout condition
- Very low-dropout voltage: 250 mV at 250 mA
- Very high PSRR: 80 dB@100 Hz, 60 dB@100 kHz
- Output voltage accuracy: 2 % across line, load and temperature
- Output voltage versions: from 1 V to 5 V, with 50 mV step
- Logic-controlled electronic shutdown
- Output discharge feature
- Internal soft-start
- Overcurrent and thermal protections
- Temperature range: from -40 °C to +125 °C
- Packages: Flip-Chip4, DFN4-1x1, SOT23-5L

Applications

- Smartphones/tablets
- Image sensors
- Instrumentation
- VCO and RF modules

Description

The LDLN025 is a 250 mA low-dropout voltage regulator, able to work with an input voltage range from 1.5 V to 5.5 V.

The typical dropout voltage at 250 mA load is 120 mV.

The very low quiescent current, which is just 12 μA at no-load, extends battery-life of applications requiring very long standby time.

Thanks to its ultra low noise value and high PSRR, the LDLN025 provides a very clean output, suitable for ultra-sensitive loads. It is stable with ceramic capacitors.

The enable logic control function puts the device into shutdown mode allowing a total current consumption lower than 1 μA .

The device also includes short-circuit and thermal protection.

Typical applications are noise sensitive loads such as ADC, VCO in mobile phones and tablets, wireless LAN devices. The LDLN025 is designed to keep the quiescent current under control and at a low value also during dropout operation, extending the operating time of battery-powered devices.

Several small package options are available.

Contents

1 Block diagram..... 3

2 Pin configuration 4

3 Typical application diagram 5

4 Maximum ratings 6

5 Electrical characteristics 7

6 Typical characteristics 10

7 Package information 15

 7.1 Flip-Chip4 package information..... 16

 7.2 Flip-Chip4 packing information..... 18

 7.3 DFN4-1x1 package information..... 19

 7.4 DFN4-1x1 packing information..... 20

 7.5 SOT23-5L package information 21

8 Ordering information..... 23

 8.1 Marking information..... 24

9 Revision history 25

1 Block diagram

Figure 1: Block diagram

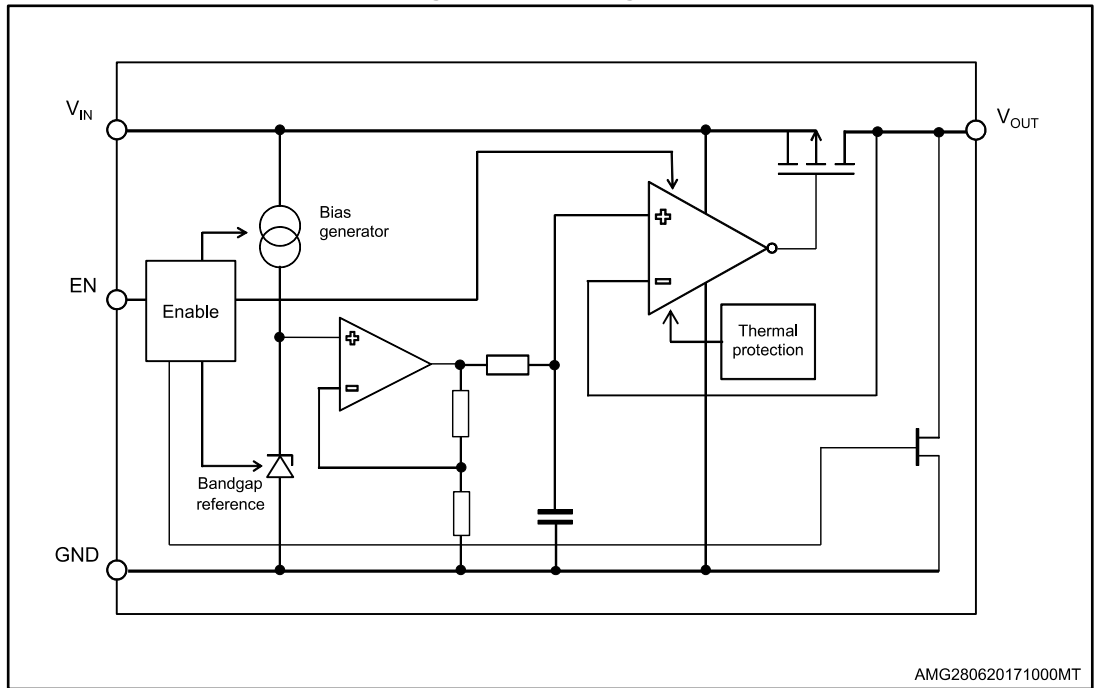

2 Pin configuration

Figure 2: Pin configuration

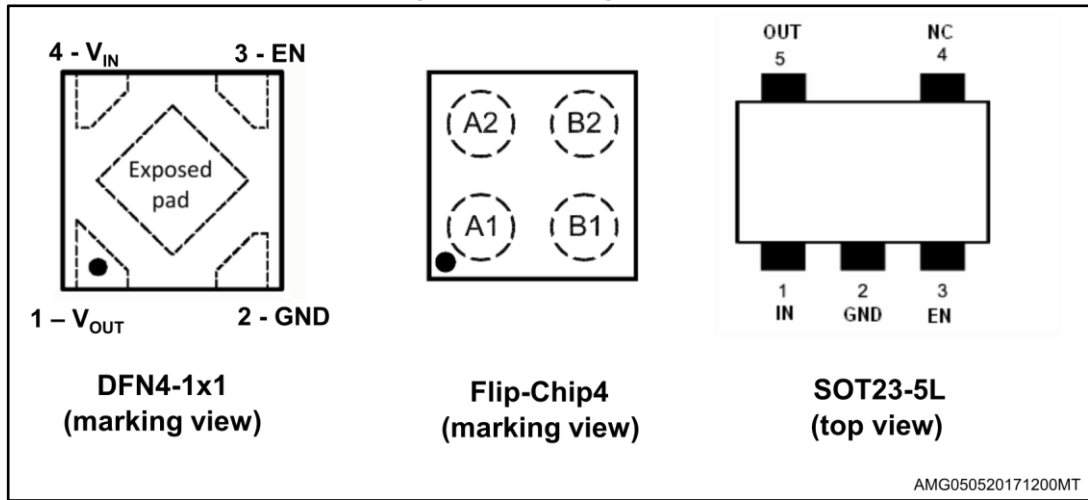
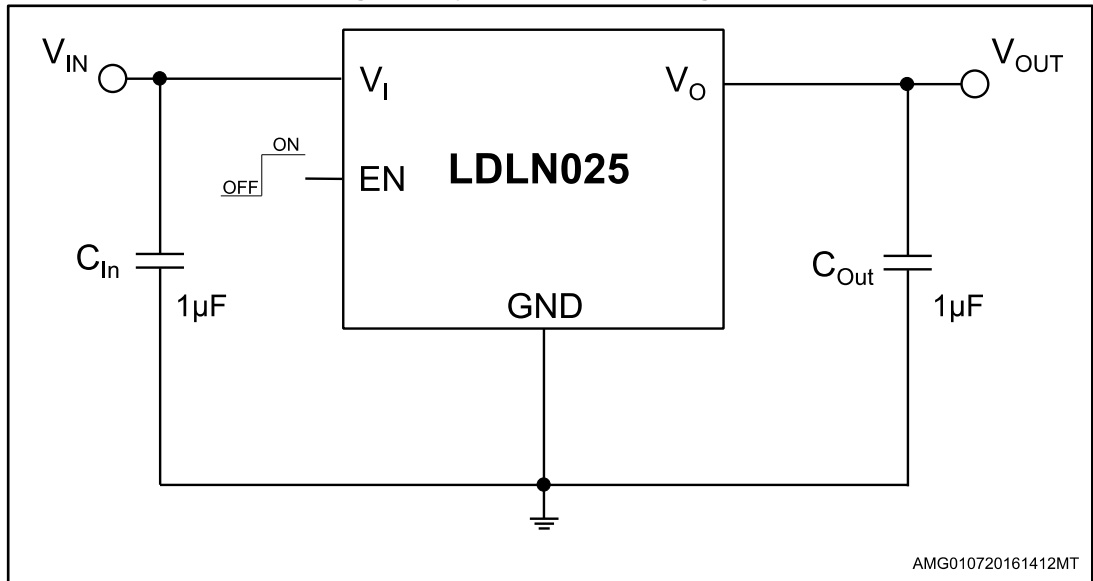

Table 1: Pin description

Symbol	DFN4-1x1	Flip-Chip4	SOT23-5L	Description
V_{IN}	4	A1	1	LDO Supply voltage
V_{OUT}	1	A2	5	LDO Output voltage
GND	2	B2	2	Ground
EN	3	B1	3	Enable input: set V_{EN} = high to turn on the device; V_{EN} = low to turn off the device This pin is internally pulled down via 1 M Ω resistor
NC	-	-	4	Not internally connected: can be connected to GND
Exposed pad	Exposed pad	-	-	Must be connected to GND

3 Typical application diagram

Figure 3: Typical application diagram



4 Maximum ratings

Table 2: Absolute maximum ratings

Symbol	Parameter	Value	Unit
V_{IN}	Input supply voltage	-0.3 to 7	V
V_{OUT}	Output voltage	-0.3 to $V_{IN} + 0.3$	V
I_{OUT}	Output current	Internally limited	A
EN	Enable pin voltage	-0.3 to $V_{IN} + 0.3$	V
P_D	Power dissipation	Internally limited	W
ESD	Charge device model	± 1000	V
	Human body model	± 2000	
T_{J-OP}	Operating junction temperature	-40 to 125	$^{\circ}C$
T_{J-MAX}	Maximum junction temperature	150	$^{\circ}C$
T_{STG}	Storage temperature	-55 to 150	$^{\circ}C$

Table 3: Thermal data

Symbol	Parameter	DFN4-1x1	Flip-Chip4	SOT23-5L	Unit
R_{thja}	Thermal resistance, junction-to-ambient	220	210	200	$^{\circ}C/W$

5 Electrical characteristics

($T_J = 25\text{ °C}$, $V_{IN} = V_{OUT(nom)} + 1\text{ V}$ or 1.5 V , whichever is greater; $V_{EN} = 1.2\text{ V}$; $C_{IN} = 1\text{ }\mu\text{F}$;
 $C_{OUT} = 1\text{ }\mu\text{F}$; $I_{OUT} = 1\text{ mA}$)

Table 4: Electrical characteristics

Symbol	Parameter	Test conditions	Min.	Typ.	Max.	Unit
V_{IN}	Operating input voltage range		1.5		5.5	V
V_{OUT}	Output voltage accuracy (Flip-Chip package)	$V_{OUT} + 1\text{ V}^{(1)} < V_{IN} < 5.5\text{ V}$, $1\text{ mA} < I_{OUT} < 0.25\text{ A}$, $V_{OUT} \geq 1.8\text{ V}$, $-40\text{ °C} < T_J < 125\text{ °C}$	-2.0		+2.0	%
		$V_{OUT} + 1\text{ V}^{(1)} < V_{IN} < 5.5\text{ V}$, $1\text{ mA} < I_{OUT} < 0.25\text{ A}$, $V_{OUT} < 1.8\text{ V}$, $-40\text{ °C} < T_J < 125\text{ °C}$	-3.0		+3.0	
V_{OUT}	Output voltage accuracy (DFN and SOT23 packages)	$V_{OUT} + 1\text{ V}^{(1)} < V_{IN} < 5.5\text{ V}$, $1\text{ mA} < I_{OUT} < 0.25\text{ A}$, $V_{OUT} \geq 1.8\text{ V}$, $-40\text{ °C} < T_J < 125\text{ °C}$	-2.0		+2.0	%
		$V_{OUT} + 1\text{ V}^{(1)} < V_{IN} < 5.5\text{ V}$, $1\text{ mA} < I_{OUT} < 0.25\text{ A}$, $V_{OUT} < 1.8\text{ V}$, $-40\text{ °C} < T_J < 125\text{ °C}$	-4.0		+4.0	
$\Delta V_{OUT}/\Delta V_{IN}$	Static line regulation	$V_{OUT} + 1\text{ V}^{(1)} < V_{IN} < 5.5\text{ V}$		0.02		%/V
		$-40\text{ °C} < T_J < 125\text{ °C}$			0.06	
	Line transient ⁽²⁾	$\Delta V_{IN} = \pm 0.6\text{ V}$, $t_{rise} = t_{fall} = 30\text{ }\mu\text{s}$	-1		+1	mV
$\Delta V_{OUT}/\Delta I_{OUT}$	Static load regulation	$1\text{ mA} < I_{OUT} < 0.25\text{ A}$, $V_{OUT} \geq 1.8\text{ V}$		0.002		%mA
		$-40\text{ °C} < T_J < 125\text{ °C}$, $V_{OUT} \geq 1.8\text{ V}$			0.007	
	Load transient ⁽²⁾	$1\text{ mA} < I_{OUT} < 0.25\text{ A}$, $V_{OUT} < 1.8\text{ V}$		20		mV
		$\Delta I_{OUT} = 1\text{ mA}$ to 250 mA and back, $t_{rise} = t_{fall} = 10\text{ }\mu\text{s}$	-40		+40	mV
ΔV_{OUT}	Overshoot on startup ⁽²⁾	Percentage of $V_{OUT(nom)}$			5	%

Symbol	Parameter	Test conditions	Min.	Typ.	Max.	Unit
V _{DROP}	Dropout voltage ⁽³⁾	I _{OUT} = 0.1 A		50		mV
		I _{OUT} = 0.25 A		120		
		I _{OUT} = 0.25 A, -40 °C < T _J < 125 °C (Flip-Chip4)			200	
		I _{OUT} = 0.25 A, -40 °C < T _J < 125 °C (DFN4-1x1)			250	
eN	Output noise voltage ⁽²⁾	f = 10 Hz to 100 kHz; I _{OUT} = 1 mA		10		μV _{RMS}
		f = 10 Hz to 100 kHz; I _{OUT} = 250 mA		6.5		
SVR	Supply voltage rejection ⁽²⁾	f = 100 Hz; I _{OUT} = 20 mA		80		dB
		f = 1 kHz; I _{OUT} = 20 mA		80		
		f = 10 kHz; I _{OUT} = 20 mA		75		
		f = 100 kHz; I _{OUT} = 20 mA		60		
I _Q	Quiescent current ⁽⁴⁾	I _{OUT} = 0 A		12		μA
		I _{OUT} = 0 A; -40 °C < T _J < 125 °C			25	
		I _{OUT} = 0.25 A		250		μA
		I _{OUT} = 0.25 A; -40 °C < T _J < 125 °C			425	
	Shutdown current	V _{EN} = 0 V		0.2	1	μA
I _{SC}	Short-circuit current	V _{OUT} = 0 V	250	500		mA
R _{LOW}	Output discharge resistance	V _{EN} = 0 V		230		Ω
V _{EN}	V _{IL} , enable input logic low	V _{OUT} + 1 V ⁽¹⁾ < V _{IN} < 5.5 V -40 °C < T _J < 125 °C			0.4	V
	V _{IH} , enable input logic high		1.2			
I _{EN}	Enable pin input current	V _{IN} = V _{EN} = 5.5 V		5.5		μA
		V _{IN} = 5.5 V; V _{EN} = 0 V		0.001		

Symbol	Parameter	Test conditions	Min.	Typ.	Max.	Unit
t_{ON}	Turn-on time ⁽²⁾	From $V_{EN} > V_{IH}$ to $V_{OUT} = 95\%$ of $V_{OUT(nom)}$		80	150	μs
T_{SHDN}	Thermal shutdown ⁽²⁾	$I_{OUT} > 1\text{ mA}$		160		$^{\circ}C$
	Hysteresis			20		

Notes:

⁽¹⁾ $V_{IN} = V_{OUT} + 1\text{ V}$ or 1.5 V , whichever is greater. Not applicable for 5 V output voltage versions.

⁽²⁾ Guaranteed by design.

⁽³⁾ Dropout voltage is the input-to-output voltage difference at which the output voltage is 100 mV below its nominal value.

⁽⁴⁾ The quiescent current is defined as $I_{IN-IOUT}$ and does not include the EN pin current.

Table 5: Recommended input and output capacitors

Symbol	Parameter	Test conditions	Min.	Typ.	Max.	Unit
C_{IN}	Input capacitance	Stability	0.7	1		μF
C_{OUT}	Output capacitance		0.7	1	10	
ESR	Output/input capacitance		5		500	$m\Omega$

6 Typical characteristics

(The following plots are referred to LDLN025J2925R in the typical application circuit and, unless otherwise noted, at $T_A = 25\text{ }^\circ\text{C}$).

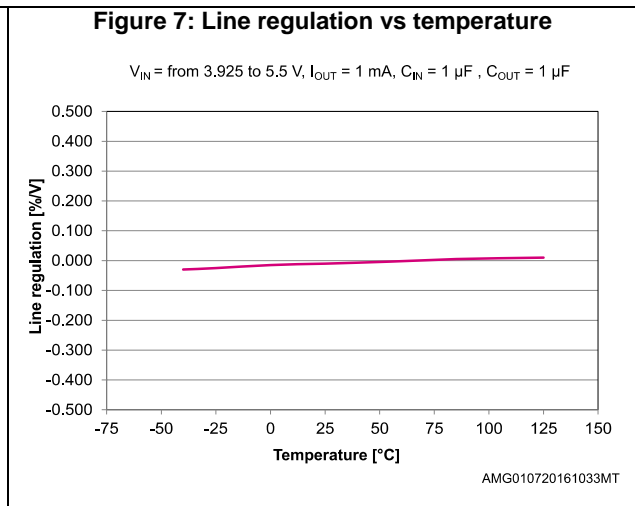
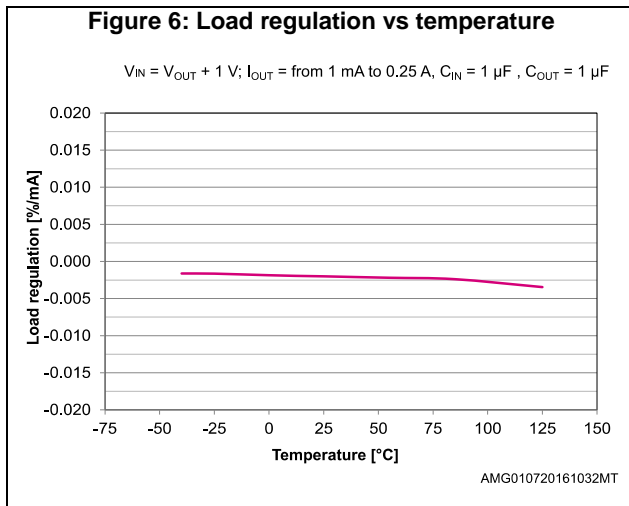
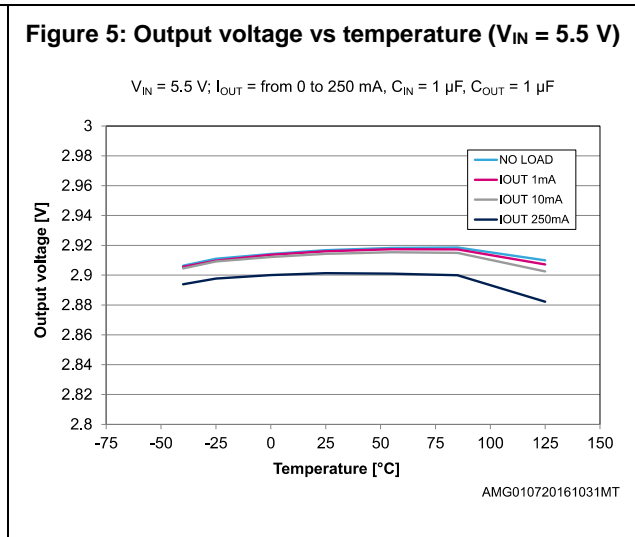
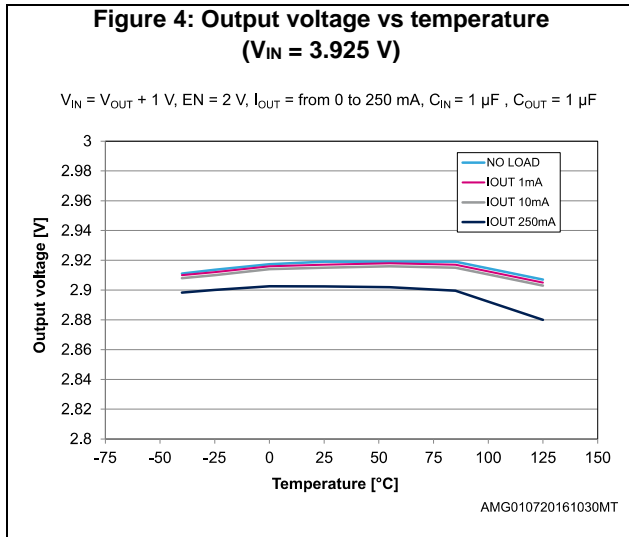

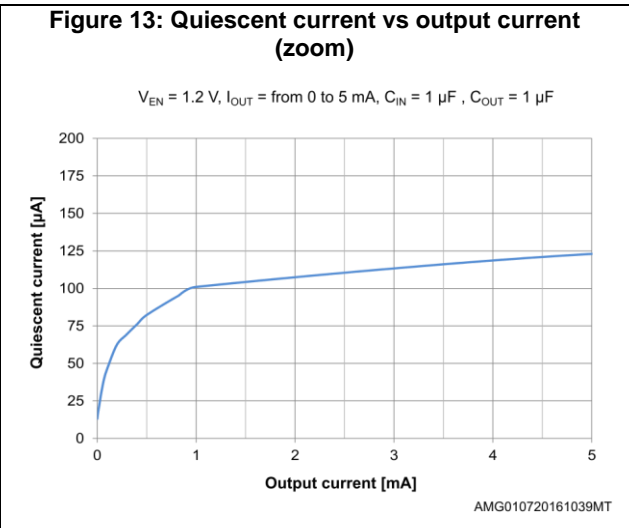
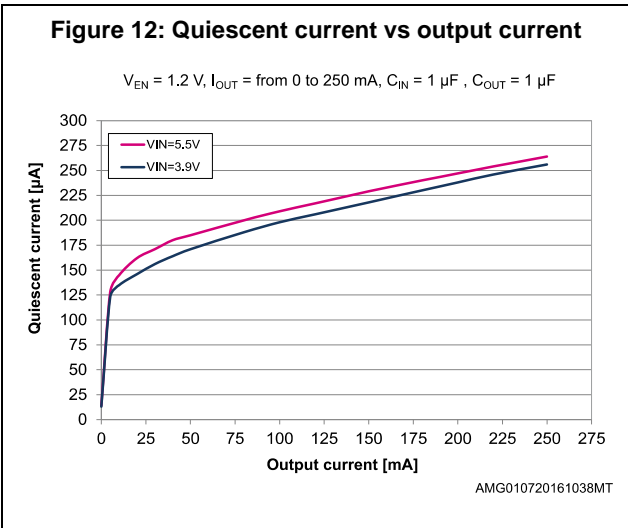
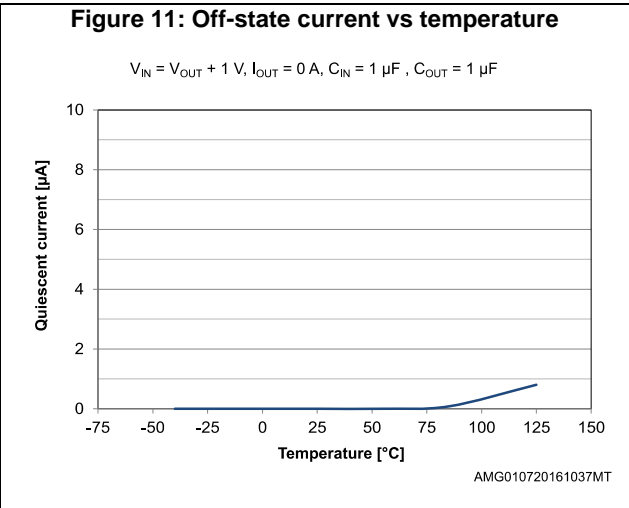
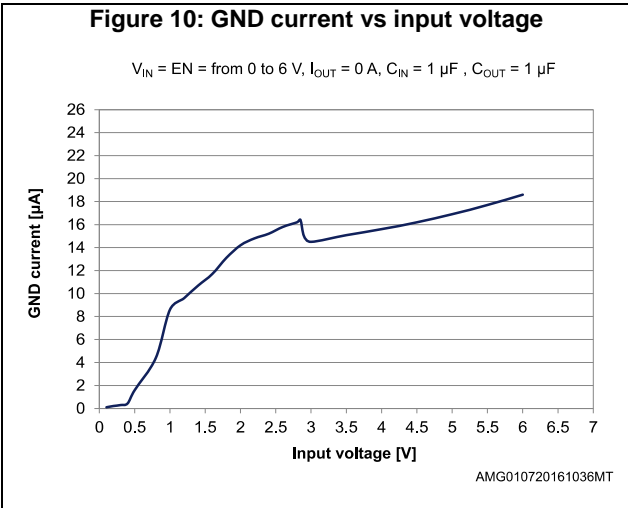
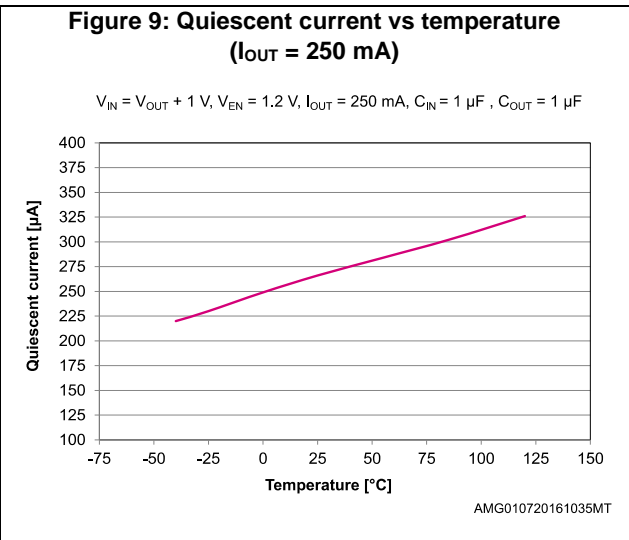
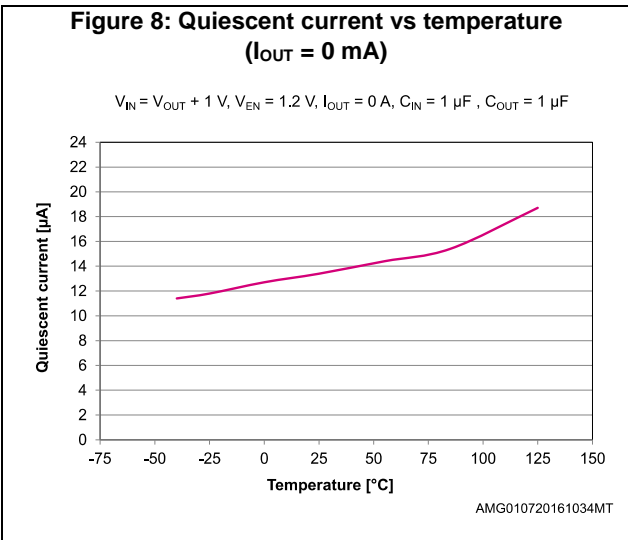

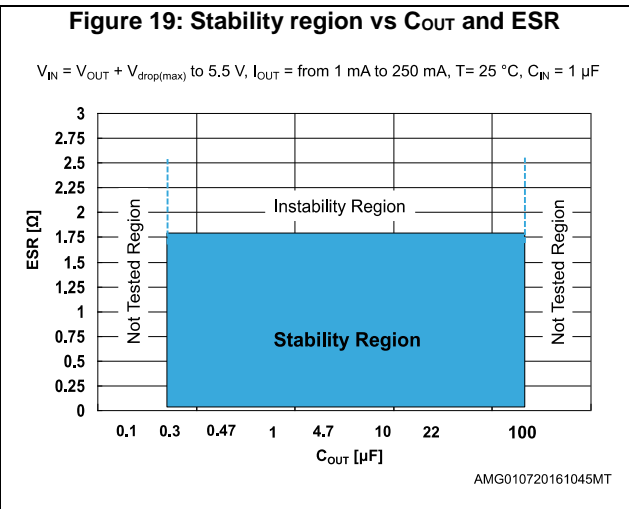
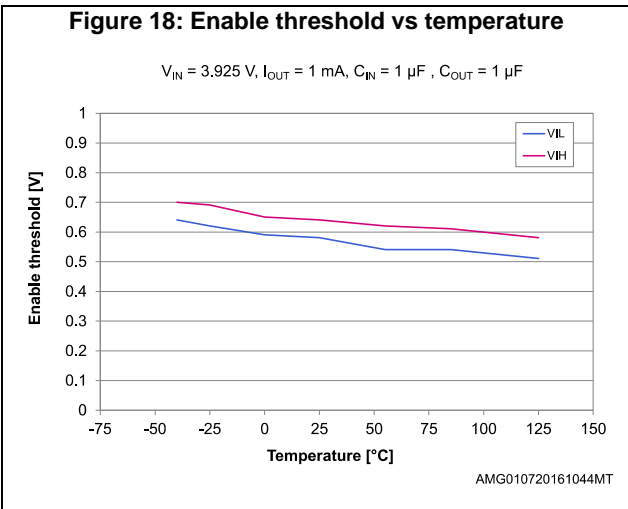
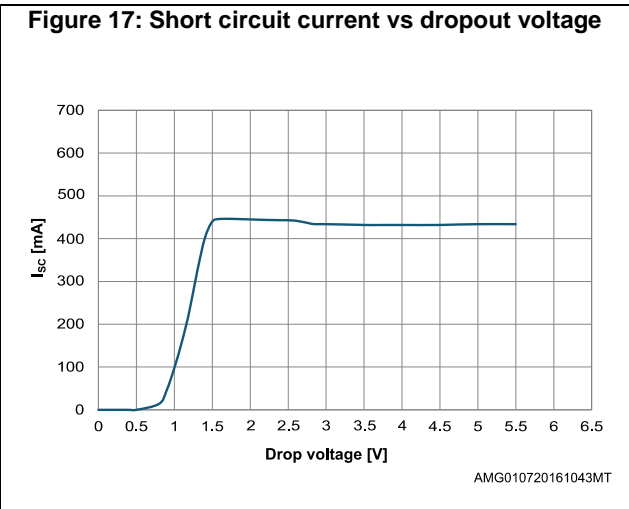
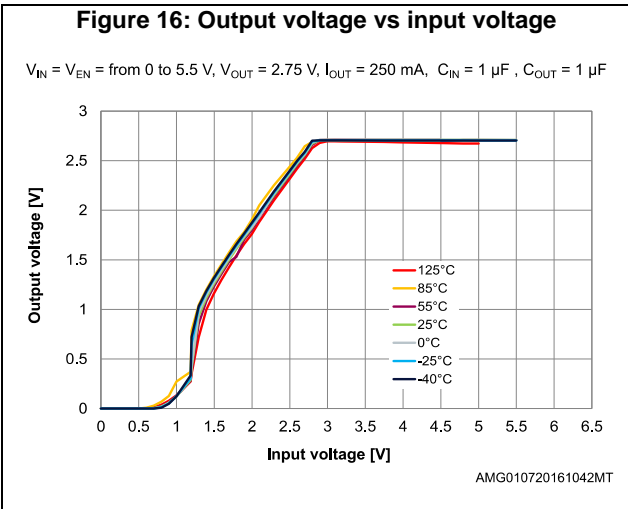
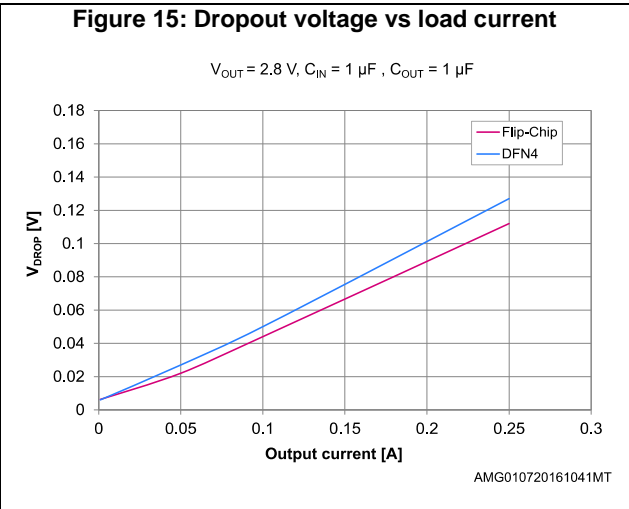
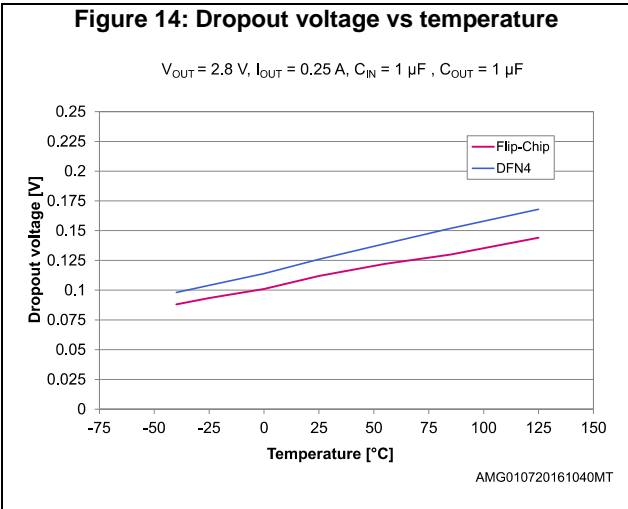
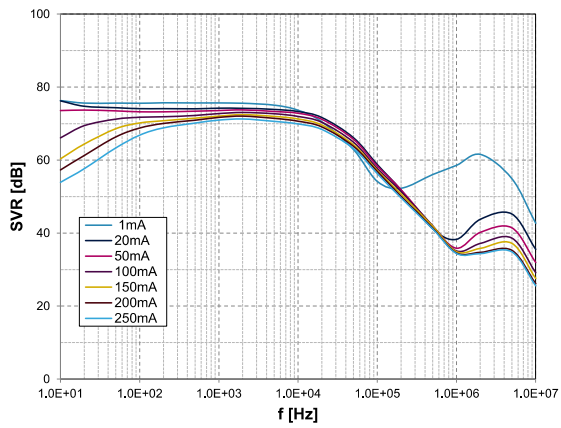

Figure 20: P_{SRR} vs frequency



V_{IN} = 3.75 V + V_{ripple}, V_{OUT} = 2.75 V, no C_{IN}, C_{OUT} = 1 μF, V_{EN} = 1.2 V

AMG010720161046MT

Figure 21: Noise density

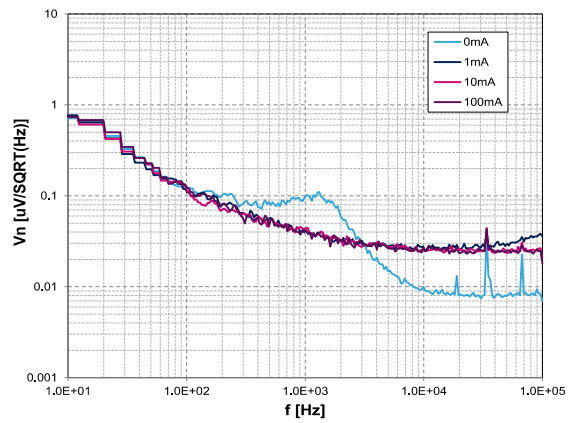

V_{IN} = 3.75 V, V_{OUT} = 2.75 V, C_{IN} = C_{OUT} = 1 μF

AMG010720161047MT

Figure 22: Line transient (I_{OUT} = 1 mA)

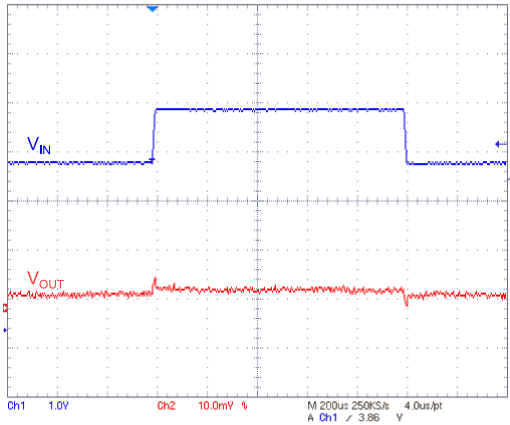

V_{IN} = from 3.4 V to 4.4 V, I_{OUT} = 1 mA, t_r = 10 μs, C_{IN} = C_{OUT} = 1 μF (X7R)

AMG010720161048MT

Figure 23: Line transient (I_{OUT} = 250 mA)

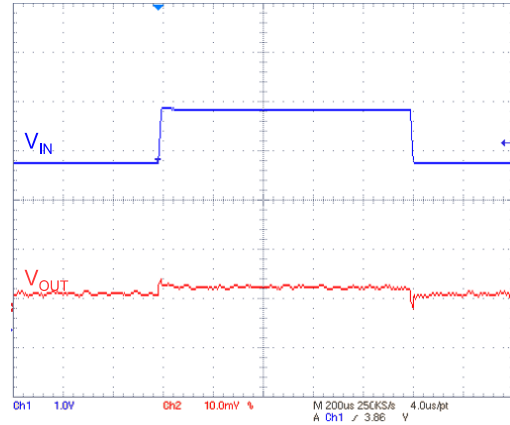

V_{IN} = from 3.4 V to 4.4 V, I_{OUT} = 250 mA, t_r = 10 μs, C_{IN} = C_{OUT} = 1 μF (X7R)

AMG010720161049MT

Figure 24: Load transient

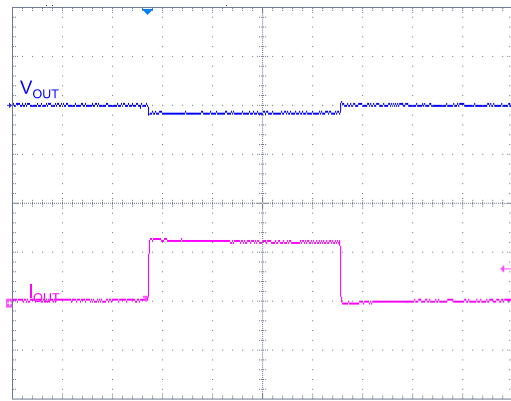

I_{OUT} = from 0 mA to 250 mA, t_r = 10 μ s, C_{IN} = C_{OUT} = 1 μ F (X7R)

AMG010720161050MT

Figure 25: Inrush current

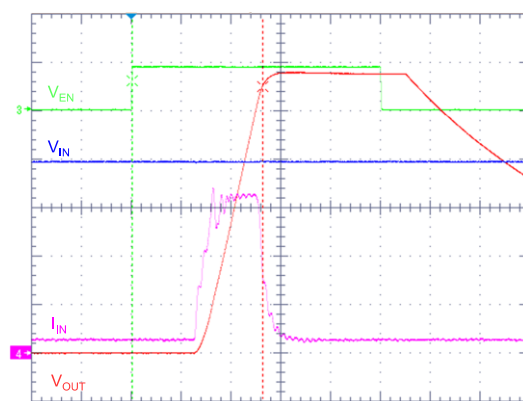

V_{IN} = 4 V, I_{OUT} = 0 mA, C_{IN} = C_{OUT} = 1 μ F (X7R)

AMG180720161000MT

Figure 26: Enable transient (I_{OUT} = 0 mA)

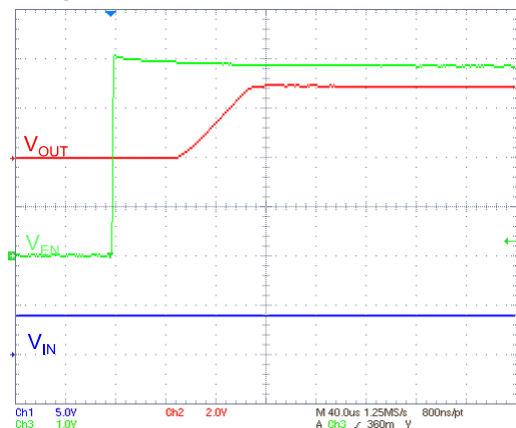

V_{IN} = 3.925 V, V_{EN} = from 0 V to 3.925 V, I_{OUT} = 0 mA, t_r = 1 μ s, C_{IN} = C_{OUT} = 1 μ F (X7R)

AMG010720161052MT

Figure 27: Enable transient (I_{OUT} = 250 mA)

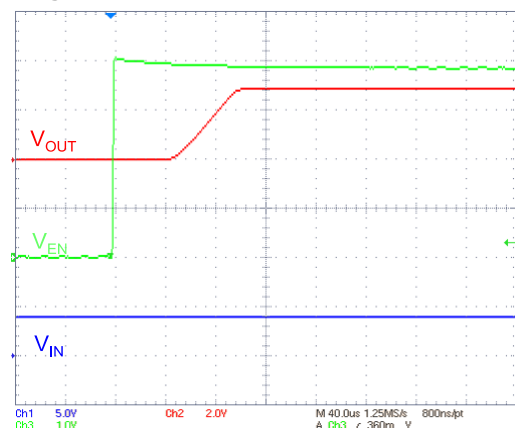

V_{IN} = 3.925 V, V_{EN} = from 0 V to 3.925 V, I_o = 250 mA, t_r = 1 μ s, C_{IN} = C_{OUT} = 1 μ F (X7R)

AMG010720161053MT

7 Package information

In order to meet environmental requirements, ST offers these devices in different grades of ECOPACK® packages, depending on their level of environmental compliance. ECOPACK® specifications, grade definitions and product status are available at: www.st.com. ECOPACK® is an ST trademark.

7.1 Flip-Chip4 package information

Figure 28: Flip-Chip4 package outline

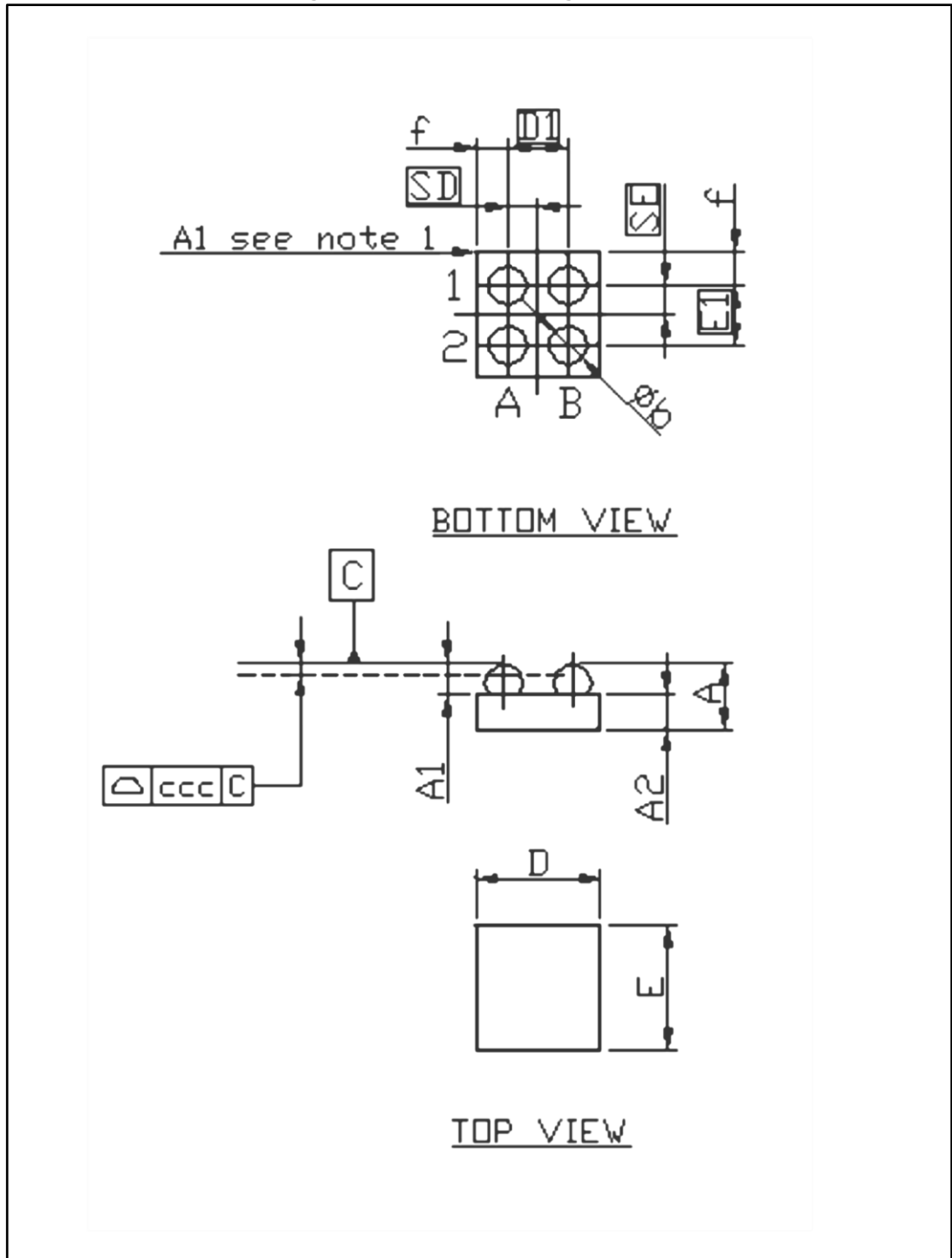
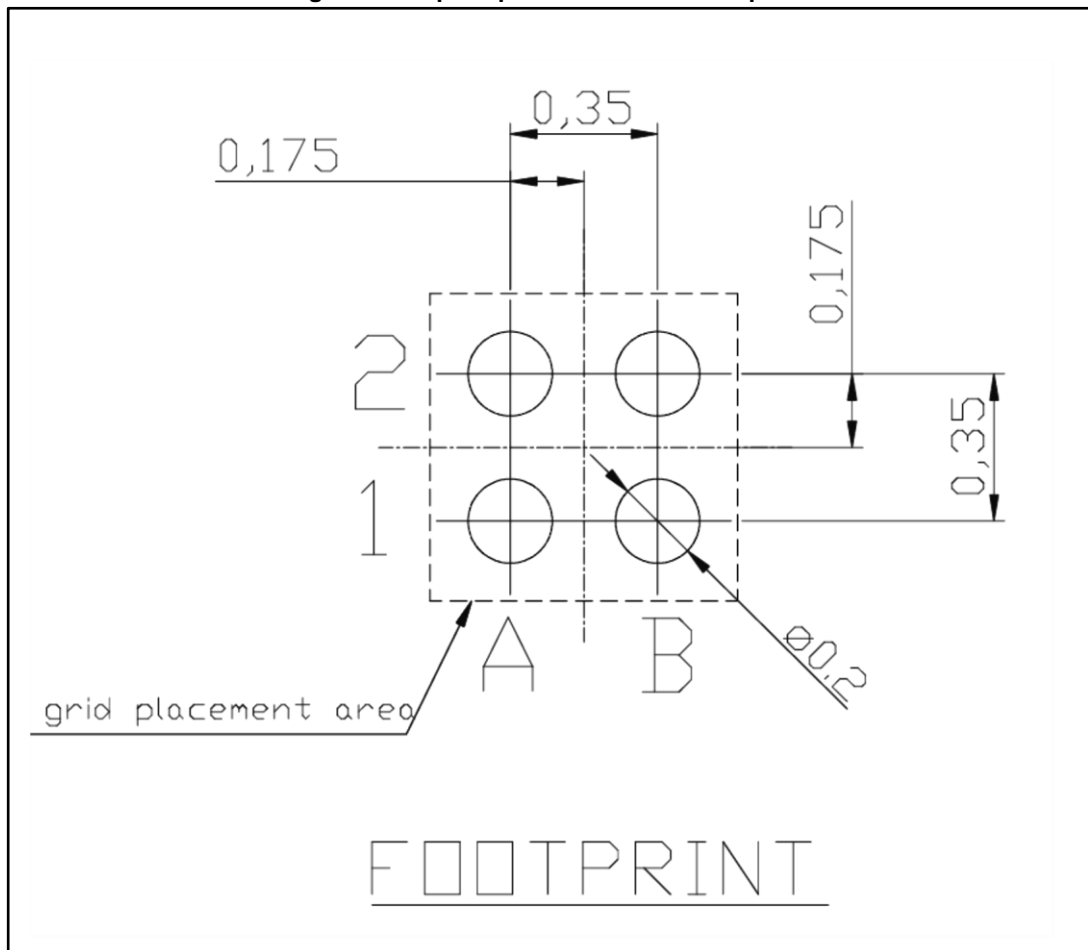

Table 6: Flip-Chip4 mechanical data

Dim.	mm		
	Min.	Typ.	Max.
A	0.375	0.410	0.445
A1	0.145	0.160	0.175
A2	0.230	0.250	0.270
b	0.189	0.210	0.231
D	0.598	0.628	0.658
D1		0.350	
E	0.598	0.628	0.658
E1		0.350	
SD		0.175	
SE		0.175	
f		0.139	
ccc		0.075	

Figure 29: Flip-Chip4 recommended footprint



7.2 Flip-Chip4 packing information

Figure 30: Flip-Chip4 carrier tape

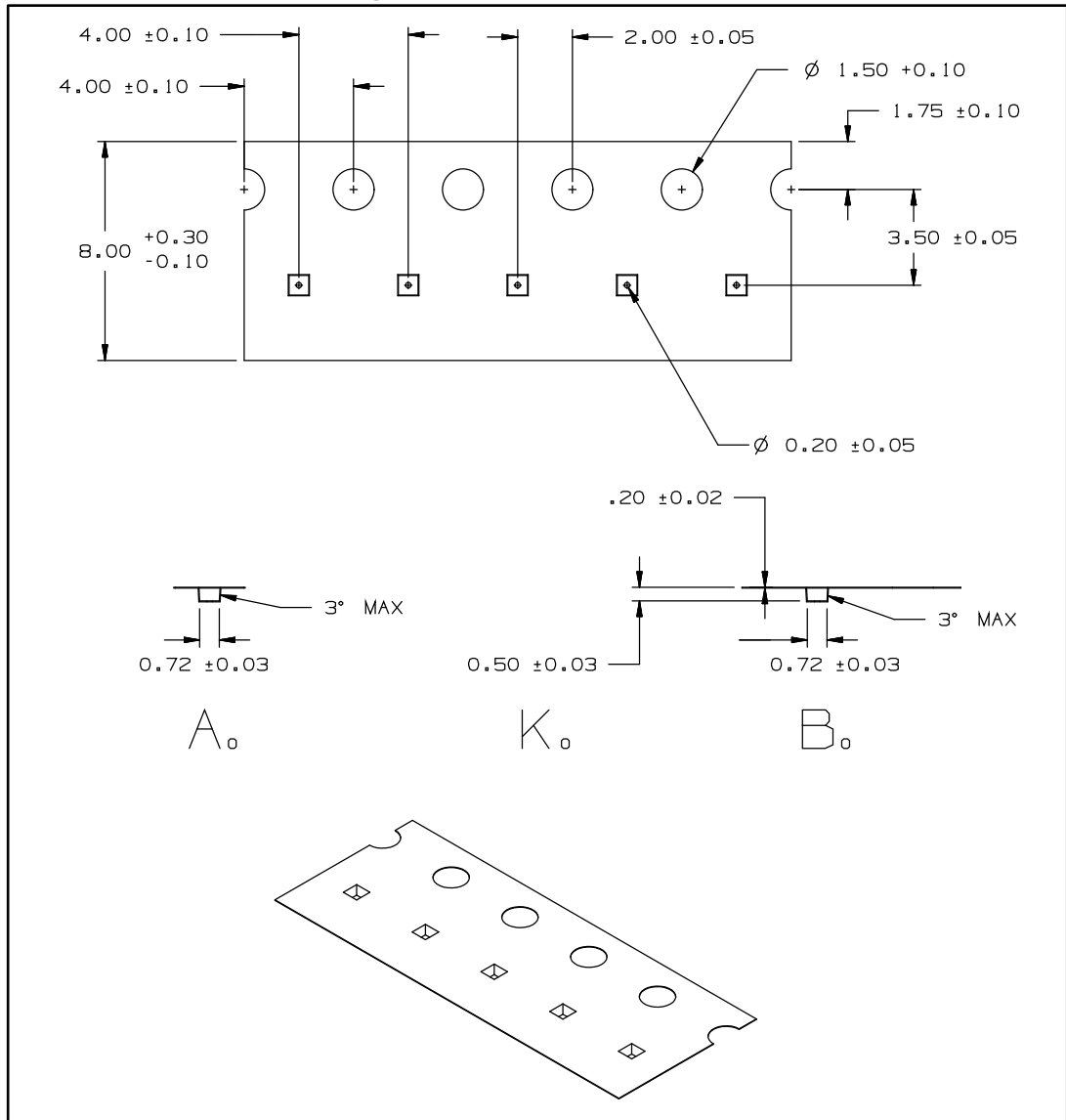

7.3 DFN4-1x1 package information

Figure 31: DFN4-1x1 package outline

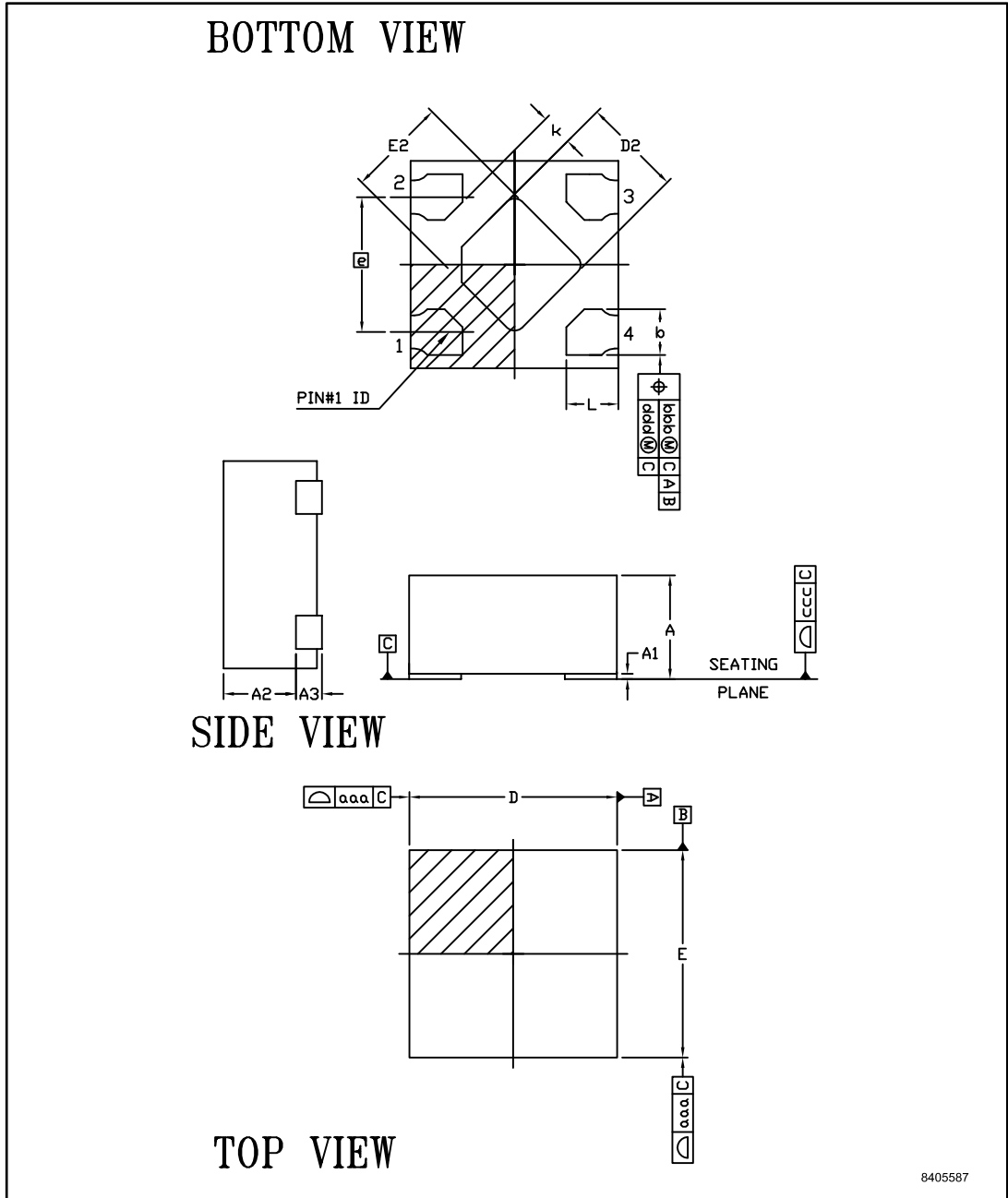
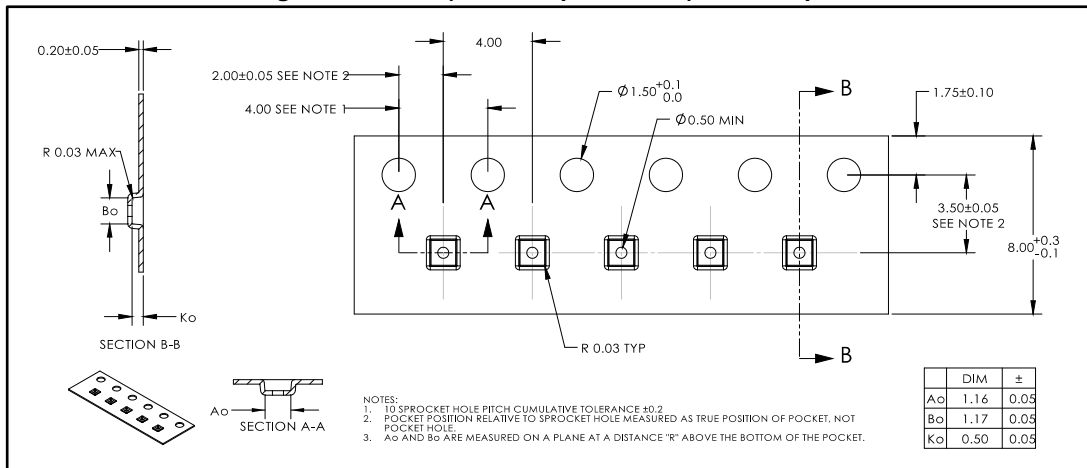

Table 7: DFN4-1x1 package mechanical data

Dim.	mm		
	Min.	Typ.	Max.
A	0.36		0.40
A1	0.00		0.05
A2	0.15	0.25	0.35
A3		0.125	
b	0.15	0.20	0.25
D	0.95	1.00	1.05
D2	0.38	0.48	0.58
e		0.65	
E	0.95	1.00	1.05
E2	0.38	0.48	0.58
L	0.15	0.25	0.35
K		0.15	
N		4	

7.4 DFN4-1x1 packing information

Figure 32: DFN4 (1x1x0.38 pitch 4 mm) carrier tape



7.5 SOT23-5L package information

Figure 33: SOT23-5L package outline

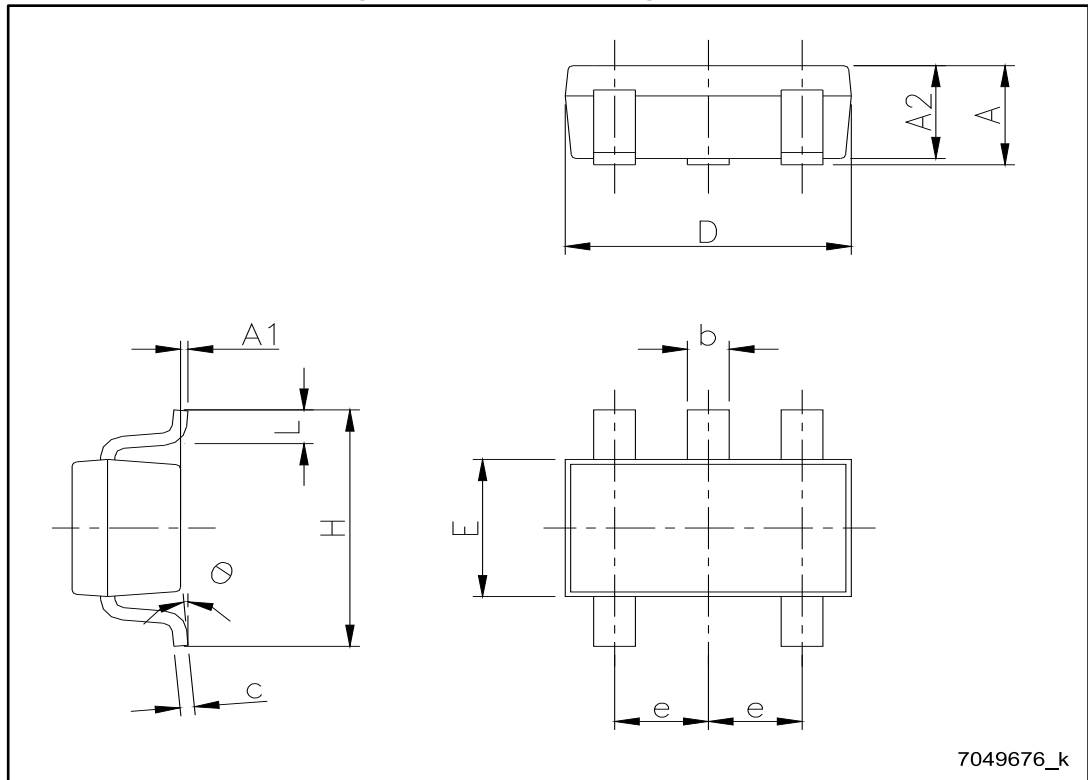
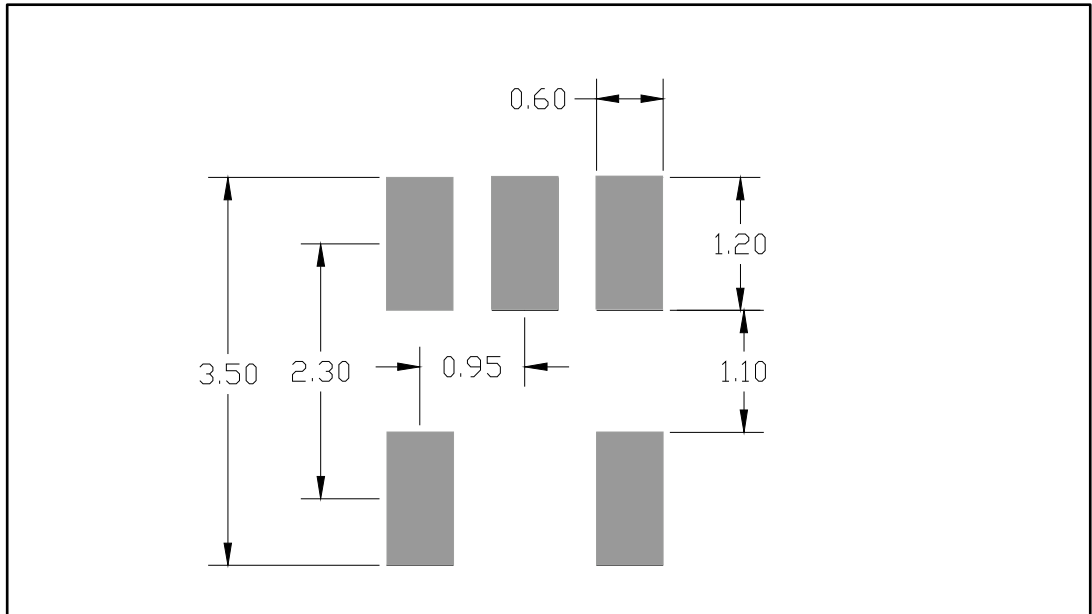

Table 8: SOT23-5L package mechanical data

Dim.	mm		
	Min.	Typ.	Max.
A	0.90		1.45
A1	0		0.15
A2	0.90		1.30
b	0.30		0.50
c	0.09		0.20
D		2.95	
E		1.60	
e		0.95	
H		2.80	
L	0.30		0.60
θ	0°		8°

Figure 34: SOT23-5L recommended footprint



Dimensions are in mm

8 Ordering information

Table 9: Order code

Order code	Package	Output voltage (V)	Marking	Packing
LDLN025PU18R	DFN4-1x1	1.8	18	Tape and reel
LDLN025PU25R		2.5	25	
LDLN025PU275R		2.75	2Z	
LDLN025PU28R		2.8	28	
LDLN025PU29R		2.9	29	
LDLN025PU30R		3.0	30	
LDLN025PU32R		3.2	32	
LDLN025PU33R		3.3	33	
LDLN025PU50R		5.0	50	
LDLN025J12R ⁽¹⁾		Flip-Chip4	1.2	
LDLN025J18R	1.8		E	
LDLN025J25R	2.5		H	
LDLN025J28R	2.8		I	
LDLN025J2925R	2.925		K	
LDLN025J30R ⁽¹⁾	3.0		G	
LDLN025J32R	3.2		N	
LDLN025J33R	3.3		F	
LDLN025J50R ⁽¹⁾	5.0		P	
LDLN025M12R ⁽¹⁾	SOT23-5L		1.2	
LDLN025M15R ⁽¹⁾		1.5	LN15	
LDLN025M18R ⁽¹⁾		1.8	LN18	
LDLN025M25R ⁽¹⁾		2.5	LN25	
LDLN025M28R ⁽¹⁾		2.8	LN28	
LDLN025M30R ⁽¹⁾		3.0	LN30	
LDLN025M33R ⁽¹⁾		3.3	LN33	
LDLN025M45R ⁽¹⁾		4.5	LN45	

Notes:

⁽¹⁾Part number in development. Contact our sales office.

8.1 Marking information

Figure 35: Flip-Chip marking composition (marking view)

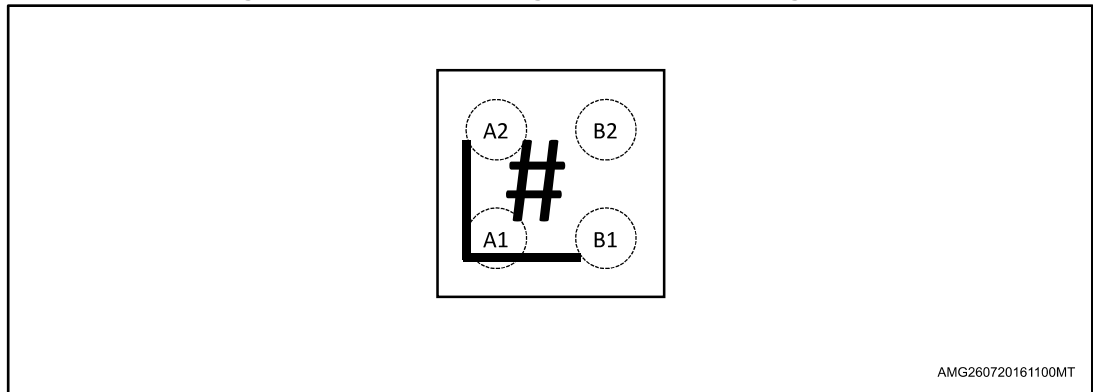

The symbol # indicates the marking digit, as per [Table 9: "Order code"](#).

9 Revision history

Table 10: Document revision history

Date	Revision	Changes
03-Aug-2016	1	First release.
01-Sep-2016	2	Updated <i>Table 8: "Order code"</i> . Minor text changes.
24-Oct-2016	3	Updated <i>Table 2: "Absolute maximum ratings"</i> . Minor text changes.
17-Nov-2016	4	Updated <i>Section 9: "Ordering information"</i> . Minor text changes.
12-Jul-2017	5	Added SOT23-5L package. Modified silhouette, features, <i>Figure 1: "Block diagram"</i> , <i>Section 2: "Pin configuration"</i> and <i>Table 4: "Electrical characteristics"</i> . Added <i>Section 7.5: "SOT23-5L package information"</i> . Updated <i>Table 9: "Order code"</i> . Minor text changes.

IMPORTANT NOTICE – PLEASE READ CAREFULLY

STMicroelectronics NV and its subsidiaries ("ST") reserve the right to make changes, corrections, enhancements, modifications, and improvements to ST products and/or to this document at any time without notice. Purchasers should obtain the latest relevant information on ST products before placing orders. ST products are sold pursuant to ST's terms and conditions of sale in place at the time of order acknowledgement.

Purchasers are solely responsible for the choice, selection, and use of ST products and ST assumes no liability for application assistance or the design of Purchasers' products.

No license, express or implied, to any intellectual property right is granted by ST herein.

Resale of ST products with provisions different from the information set forth herein shall void any warranty granted by ST for such product.

ST and the ST logo are trademarks of ST. All other product or service names are the property of their respective owners.

Information in this document supersedes and replaces information previously supplied in any prior versions of this document.

© 2017 STMicroelectronics – All rights reserved

Mouser Electronics

Authorized Distributor

Click to View Pricing, Inventory, Delivery & Lifecycle Information:

STMicroelectronics:

[LDLN025M18R](#) [LDLN025M12R](#) [LDLN025M25R](#) [LDLN025M30R](#) [LDLN025M33R](#) [LDLN025M28R](#) [LDLN025M15R](#)
[LDLN025M45R](#)